

NASA CONTRACTOR REPORT 166315

NASA-CR-166315
19820014374

Functional Requirements For the
Man-Vehicle Systems Research Facility

Warren F. Clement
R. Wade Allen
Robert K. Heffley
Wayne F. Jewell
Henry R. Jex
Duane T. McRuer
Ted M. Schulman
Robert L. Stapleford

CONTRACT NAS2-10400
October 1980

NASA

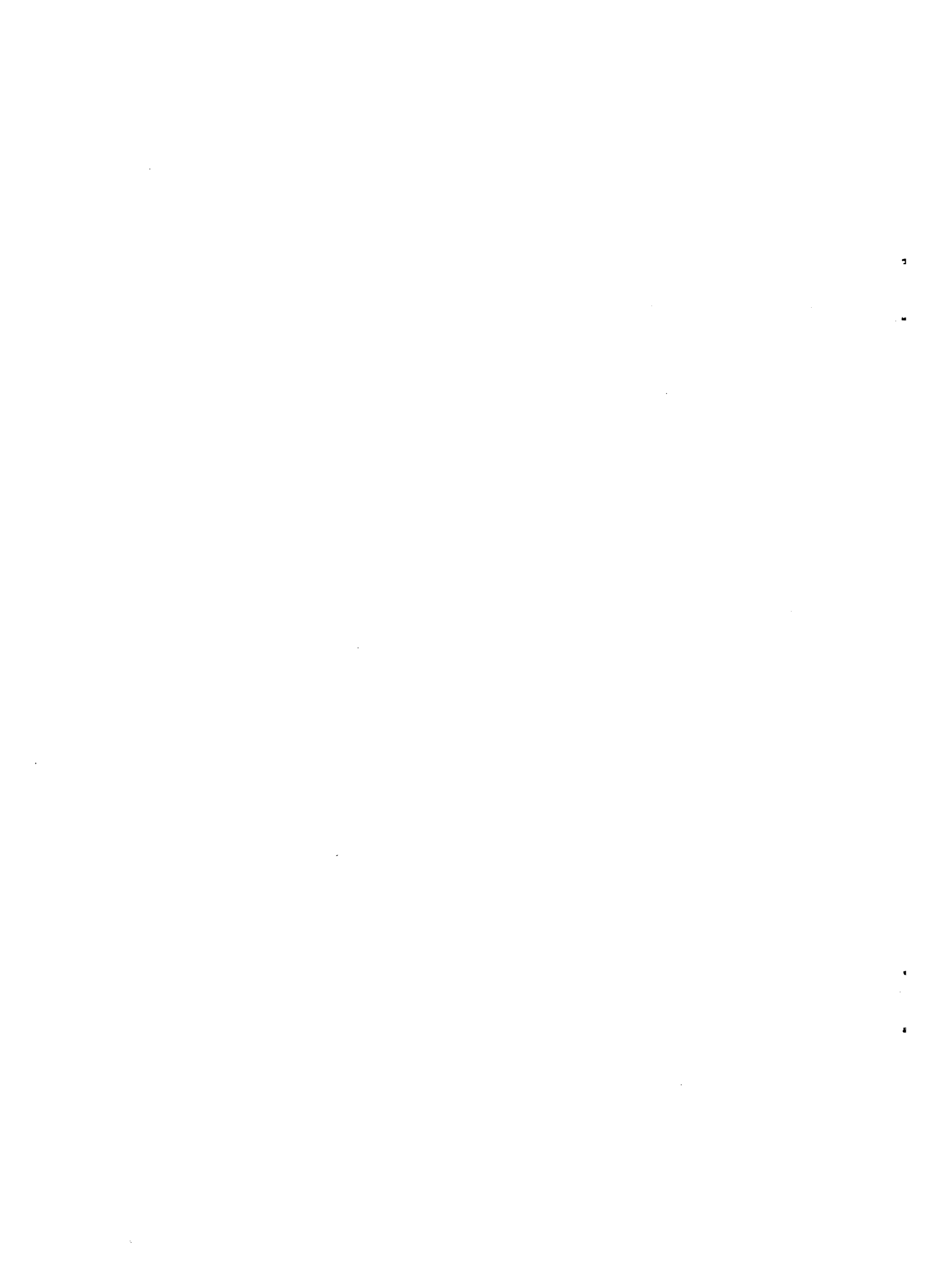

NASA CONTRACTOR REPORT 166315

Functional Requirements For the
Man-Vehicle Systems Research Facility

Warren F. Clement
R. Wade Allen
Robert K. Heffley
Wayne F. Jewell
Henry R. Jex
Duane T. McRuer
Ted M. Schulman
Robert L. Stapleford

Systems Technology, Inc.
13766 South Hawthorne Blvd.
Hawthorne, California 90250

Prepared for
Ames Research Center
under Contract NAS2-10400



National Aeronautics and
Space Administration

Ames Research Center
Moffett Field, California 94035

N82-22248 #

1

2

3

4

ABSTRACT

Human error is a significant contributing factor in a very high proportion of civil transport, general aviation, and rotorcraft accidents. Finding ways to reduce the number and severity of human errors would thus appear to offer promise for a significant improvement in aviation safety. Human errors in aviation tend to be treated in terms of clinical and anecdotal descriptions, however, from which remedial measures are difficult to derive. Correction of the sources of human error requires that one attempt to reconstruct underlying and contributing causes of error from the circumstantial causes cited in official investigative reports. Relevant measurements based on a comprehensive analytical theory of the cause-effect relationships governing propagation of human error are indispensable to a reconstruction of the underlying and contributing causes. At present there is no national capability to implement the part- or full-mission flight simulation studies which are necessary to support the relevant measurements in the context of the national airspace system. NASA Ames Research Center has therefore proposed the Man-Vehicle Systems Research Facility to support the flight simulation studies which are needed for identifying and correcting the sources of human error associated with current and future air carrier operations. This report reviews the proposed organization of the Man-Vehicle Systems Research Facility and recommends functional requirements and related priorities for the facility based on a review of potentially critical operational scenarios. Requirements are included for the experimenter's simulation control and data acquisition functions, as well as for the visual field, motion, sound, computation, crew station, and intercommunications subsystems. The related issues of functional fidelity and level of simulation are addressed, and specific criteria for quantitative assessment of various aspects of fidelity are offered. The report concludes with recommendations for facility integration, checkout, and staffing.

FOREWORD

This report was prepared under NASA Contract NAS2-10400 sponsored by the Man-Vehicle Systems Research Division of Life Sciences at the Ames Research Center of the National Aeronautics and Space Administration. The contract technical monitor was Dr. David C. Nagel; the Systems Technology, Inc., (STI) technical director was Mr. Duane T. McRuer; and the STI project engineer was Mr. Warren F. Clement. This report was prepared during the interval from November 1979 through October 1980.

The authors have endeavored to acknowledge by textual reference the specific contributions of the many other researchers which have helped to make this work possible. In addition the authors wish to thank the following individuals for their assistance in preparing this volume: the contract technical monitor for his constructive criticism and guidance, and Sharon A. Duerksen of the STI staff for her help in publishing the volume itself.

TABLE OF CONTENTS

Section		Page
I	INTRODUCTION.....	1
	A. Review of MVSFR Requirements.....	2
	B. Functional Organization of the Facility.....	4
	1. Current Technology Simulation.....	6
	2. Air Traffic Control Simulation.....	13
	3. Advanced Technology Simulation.....	16
	C. Critical Operational Scenarios.....	20
	D. Organization of the Report.....	23
II	FUNCTIONAL FIDELITY.....	25
	A. Definitions.....	25
	1. Understanding What is Meant by Fidelity and Validity.....	25
	2. An Operational Definition of Fidelity.....	28
	B. Levels of Simulation.....	32
	C. Criteria for Fidelity of the Simulated IFR Cockpit, External Visual Field, and Motion and Aural Cues.....	39
	1. Head-Down Cockpit Displays, Controls, and Procedures.....	40
	2. Visual Cues (Including Head-Up Displays).....	41
	3. Motion Cues.....	41
	4. Aural Cues.....	43
	5. Element of Surprise.....	44
	6. Summary.....	44

TABLE OF CONTENTS (Continued)

Section		Page
III	VISUAL FIELD.....	47
	A. Field of View.....	47
	B. Resolution.....	48
	C. Color.....	50
	D. Interactive Image Generation.....	52
	1. Night Visual Graphics.....	53
	2. Computer-Generated Image (CGI) Display System.....	59
	E. Image Presentation Optics.....	61
	1. CRT and Wide-Angle TV.....	61
	2. CRT and Collimating Lens.....	61
	F. Update Rate.....	65
	G. Summary.....	67
IV	MOTION CUES.....	69
	A. Tracking.....	69
	B. Failure Detection.....	71
	C. Discrete Maneuvers.....	72
	D. Illusions and Disorientation.....	76
	E. Summary.....	78
	F. Recommended Motion Simulation System.....	79
V	ASSESSING THE FIDELITY OF VEHICLE AND ENVIRONMENTAL MODELS.....	83
	A. Simplified CTOL Pilot-Vehicle Dynamics.....	85
	B. Simplified STOL Pilot-Vehicle Dynamics.....	90
	C. Summary.....	94

TABLE OF CONTENTS (Continued)

Section		Page
VI	COMPUTER SELECTION CONSIDERATIONS.....	95
	A. Digital Systems.....	95
	B. Digital Interfaces.....	102
	C. Hybrid Systems.....	102
VII	SOFTWARE.....	105
	A. The Computer Operating System.....	105
	B. The Experimenter's Executive.....	107
	C. The Real-Time Running Modules.....	109
	1. Background.....	109
	2. Operate Mode.....	110
	3. Real-Time Scheduling.....	113
	4. MAIN Task Description.....	116
	5. Accessing Program Parameters.....	119
	6. Subroutine SETUP.....	120
	7. Subroutine SLOOP1.....	121
	8. Subroutine SLOOP2.....	122
VIII	FLIGHT CREW STATION.....	125
	A. External Visual Field and Head-Up Displays.....	127
	B. Primary Head-Down Displays.....	127
	1. Vertical Situation Display (VSD).....	127
	2. Horizontal Situation Display (HSD).....	128
	3. Multipurpose Display (MPD).....	128

TABLE OF CONTENTS (Continued)

Section	Page
4. Status Advisory Display (SAD).....	129
5. Flight Instruments.....	129
C. Display Graphics Generator.....	129
D. Controls and Control Loading.....	131
E. Flight Instruments.....	131
F. Programmable Multifunction Keyboard.....	132
IX EXPERIMENTER'S CONSOLE AND DATA ACQUISITION SYSTEM.....	135
A. Current Technology Simulation Console.....	135
B. Advanced Technology Simulation Console.....	138
1. Head-Up Display and Visual Field Display Monitor, Vertical Situation Display Monitor, and Horizontal Situation Display Monitor.....	141
2. Multipurpose Display Monitors and Status Advisory Display Monitors.....	141
3. Backup Flight Instruments.....	141
4. Simulator Status Displays and Interactive Controls.....	141
5. Comfort Status Displays (e.g., Cockpit Temperature) and Crew Performance Monitor Displays and Control.....	144
6. Audio Intercommunication Controls.....	146
7. Malfunction Simulation Controls.....	146
8. Facility Power and Environmental Controls.....	148

TABLE OF CONTENTS (Concluded)

Section	Page
X	FACILITY INTEGRATION, CHECKOUT, AND STAFFING..... 149
A.	Facility Integration..... 149
B.	Implementation of Simulator Models..... 150
1.	Definition Phase..... 150
2.	Implementation Phase..... 150
3.	Check-Out Phase..... 151
4.	Fidelity Documentation..... 152
C.	Simulation Test Plan Development..... 152
1.	Task Analysis..... 152
2.	Unmanned Simulation of Tasks..... 153
3.	Layout of Test Plan and Schedule..... 153
D.	Staffing..... 154
XI	CONCLUSIONS AND RECOMMENDATIONS..... 157
REFERENCES 159
Appendix	
A	A UNIFIED MEASURE OF VISUAL FIELD FIDELITY..... 169
B	EFFECTS OF VARIOUS LATERAL-BEAM-MOTION WASHOUTS ON PILOT TRACKING AND OPINION IN THE "LAMAR" SIMULATOR..... 175
C	CONTROL-FEEL SYSTEM CHARACTERISTICS..... 183
1.	Functions to be Simulated..... 186
2.	Modular Feel Packages..... 189
D	PLASMA DISPLAY TERMINAL AND PROGRAMMABLE MULTIFUNCTION KEYBOARD..... 195

LIST OF TABLES

Number		Page
1	Functions Recommended for the Current Technology Flight Simulation of a Commercial Transport.....	8
2	Number and Type of Signals For the MVSRF I/O Subsystem (From Ref. 5).....	10
3	Functions Recommended for the Air Traffic Control System Simulation in the MVSRF.....	15
4	Functions Recommended for the Advanced Technology Flight Simulation of a Commercial Transport.....	18
5	Critical Operational Situations Requiring Simulation for the Purpose of Investigating Human Error.....	21
6	Some Critical Operational Situations Which will Constrain the Design of Simulation Elements.....	22
7	Functional Attributes of a Visual Simulator.....	27
8	A Summary Definition of Simulator Fidelity.....	33
9	Comparison of Three Levels of Simulation.....	36
10	Electronic Approaches for Generating Interactive Visual Fields.....	54
11	Comparison of Graphics Systems.....	55
12	Evans and Sutherland Multi-Picture System.....	56
13	Computer-Generated Information Displays for Visual Field Generation.....	60
14	Consideration for Large Fixed Screen Versus Cockpit- Mounted Visual Field Simulators.....	64
15	Motion System Design Requirements.....	80
16	Comparison of Some Host Computer Systems Employing 32-bit Words with Recommended Requirements from Refs. 3 and 5.....	96

LIST OF TABLES (Concluded)

Number		Page
17	Comparison of Minicomputer Systems Employing 16-bit Words.....	98
18	Input/Output (I/O) Functions.....	112
19	Specifications for McFadden Cockpit Simulator Instruments.....	133
20	Recommended Man-Vehicle System Research Simulation Facility.....	158
C-1	Cockpit Controls and Feel Characteristics.....	184
C-2	Situations Defining Control Requirements.....	185

LIST OF FIGURES

Number		Page
1	Overall Functional Organization of the Man Vehicle Systems Research Facility (MVSRF).....	5
2	Functional Organization of the Current Technology Simulation in the MVSRF.....	7
3	Functional Organization of the ATC Simulation in the MVSRF.....	14
4	Functional Organization of the Advanced Technology Simulation in the MVSRF.....	17
5	Anecdotal Experience with Vertigo Versus Screen/Size When Viewing Dynamic Scenes from a Fixed-Base Situation.....	49
6	Pilot Opinion for Simulator Displays Compared to Real World Fidelity.....	51
7	Example of Wide-Angle Projection TV System for Presenting a Visual Field Appropriate to Night Operations.....	62
8	Low Frequency Corrections for Gravity.....	74
9	Sketches of Amplitude Response of Altitude Due to Gusts.....	89
10	Assumed Pilot-Vehicle Loop Structure for Longitudinal-Vertical Control in Low Speed Flight.....	91
11	Height Response Amplitude Asymptotes for Gust Disturbances.....	92
12	Facility Software Requirements for the Current and Advanced Technology Simulations.....	106
13	Examples of Operate Mode Scheduling.....	114
14	Recommended Duplex Signal Routine for Acquiring and Monitoring Experimental Data.....	139
15	Example of Facility Operator's Communications Panel.....	140
16	Recommended Experimenter' Console Layout for Advanced Technology Simulation.....	142

LIST OF FIGURES (Concluded)

Number		Page
17	System and Pilot Dynamic Response, Cognitive or Control Capacity, and Scanning Workload Measurements for Evaluation.....	145
18	Example of Traffic Controller Station.....	147
A-1	Comparison of Deceleration Profiles Between Analytical Model and Flight Test Data.....	170
B-1	Boundaries of Sway-Axis Washout Filter Parameters (From Ref. B-1) Which Delineate the Pilots' Impressions of Realism from Combined Roll and Sway Motion Cues.....	178
B-2	Summary of Pilot Commentary for Bank and Stop Maneuvers and Roll Tracking.....	179
C-1	Elements of Control Feel System Characteristics.....	187

LIST OF ABBREVIATIONS

ACARS	Automatic Communications and Reporting System
A/D	Analog to digital
ANSI	American National Standards Institute
APU	Auxiliary power unit
ARINC	Aeronautical Radio, Inc.
ATC	Air traffic control
ATIS	Automatic Terminal Information Service
BCAS	Beacon Collision Avoidance System
C.A.T	Clear air turbulence
CDTI	Cockpit Display of Traffic Information
CGI	Computer generated image
cpu	Central processing unit
CRT	Cathode ray tube
CTOL	Conventional takeoff and landing
D/A	Digital to analog
DABS	Discrete Address Beacon System
DC	Direct current
DEC	Digital Equipment Corporation
DES	Dynamic Environment Simulator
DLC	Direct lift control
DOF	Degrees of freedom
EADI	Electronic Attitude Director Indicator
EAI	Electronic Associates, Inc.
EEG	Electroencephalograph

LIFT OF ABBREVIATIONS (Continued)

EHSI	Electronic Horizontal Situation Indicator
EKG	Electrocardiograph
EMG	Electromyograph
EPR	Engine pressure ratio
ETA	Estimated time of arrival
E&S	Evans and Sutherland
FAA	Federal Aviation Administration
FLOLS	Fresnel Lens Optical Landing System
FMS	Flight Management System
FSAA	Flight Simulator for Advanced Aircraft
GE	General Electric
HDD	Head down display
HSD	Horizontal situation display
HUD	Head up display
IC	Initial condition
ICAO	International Civil Aviation Organization
IEEE	Institute of Electrical and Electronic Engineers
IFR	Instrument flight rules
IMC	Instrument meteorological conditions
intercom	Intercommunication
I/O	Input/output
IR	Infra-red
ITC	Instrumentation Technology Corporation
LAMARS	Large Amplitude Multi-Mode Research Simulator

LIST OF ABBREVIATIONS (Continued)

LDS	Line Drawing System
MIL	Military
M.I.T.	Massachusetts Institute of Technology
MOS	Metallic Oxide Semiconductor
MPD	Multipurpose display
MPS	Multi-Picture System
MVSRF	Man-Vehicle Systems Research Facility
NAFEC	National Aviation Facilities Experimental Center
NASA	National Aeronautics and Space Administration
NL	Nonlinear
RGB	Red-green-blue
NOVOVIEW	Night-Only Visual Optical View
rpm	Revolutions per minute
SAAB	Svenska Aeroplan Aktiebolaget, Linkoping, Sweden
SAD	Status advisory display
SEL	Systems Engineering Laboratories
SOP	Successive Organization of Perception
STD	Standard
STI	Systems Technology, Inc.
STOL	Short takeoff and landing
TEPIGEN	Television Picture Generation
TOD	Top of descent
TV	Television
VFA	Visual flight attachment

LIST OF ABBREVIATIONS (Concluded)

VFR	Visual flight rules
VITAL	Virtual Image Takeoff and Landing (System)
VMC	Visual meteorological conditions
VSD	Vertical situation display
VTOL	Vertical takeoff and landing
WPAFB	Wright-Patterson Air Force Base

LIST OF SYMBOLS

C_D	Drag coefficient (dimensionless)
$C_{D\alpha}$	$\partial C_D / \partial \alpha$; partial derivative of drag coefficient with angle of attack (1/rad)
C_L	Lift coefficient (dimensionless)
$C_{L\alpha}$	$\partial C_L / \partial \alpha$; partial derivative of lift coefficient with angle of attack (1/rad)
g	Gravitational acceleration (ft/sec ²)
K_d	Pilot's glide slope displacement gain compensation (rad/ft)
K_u	Pilot's airspeed gain compensation (rad/ft/sec)
L_u	Scale length of longitudinal gust velocity, u_g
m	Aircraft mass (slugs)
s	Laplace transform operator (1/sec)
S	Reference wing area (ft ²)
T_u	Closed-loop time constant of airspeed control mode: $\frac{1}{\omega_{c_u}}$ (sec)
u_a	Change in aircraft airspeed with respect to trimmed airspeed (ft/sec)
u_g	Longitudinal or horizontal gust velocity or wind shear component (ft/sec)
\dot{u}_g	$\partial u / \partial t$, longitudinal or horizontal gust acceleration (ft/sec ²) or rate of shear
V	Aircraft trimmed airspeed (ft/sec)
$V_{inertial}$	Inertial aircraft velocity (ft/sec)
w_g	Normal or vertical gust velocity or wind shear component (ft/sec)
W	Aircraft weight (lb)
X	Longitudinal force (lb)

LIST OF SYMBOLS (Continued)

X_u	$\frac{1}{m} \frac{\partial X}{\partial u}$ (1/sec), the derivative of X-force with respect to airspeed; represents surge damping and is equal to $(-\rho g C_D V)/(W/S)$
X_w	$\frac{1}{m} \frac{\partial X}{\partial w}$ (1/sec), the derivative of X-force with respect to normal velocity; is equal to $[\rho g (C_L - C_{D_\alpha}) V]/(2W/S)$
X_α	$V X_w$ (ft/sec ²)
X_{δ_T}	$\frac{1}{m} \frac{\partial X}{\partial \delta_T}$ (ft/sec ² -rad), the derivative of X-force with respect to throttle displacement.
Z	Normal force (lb)
Z_u	$\frac{1}{m} \frac{\partial Z}{\partial u}$ (1/sec), the derivative of Z-force with respect to airspeed, is equal to $(-\rho g C_L V)/(W/S)$ in general and $(-2g)/V$ in level flight
Z_w	$\frac{1}{m} \frac{\partial Z}{\partial w}$ (1/sec), the derivative of Z-force with respect to normal velocity; represents heave damping and is equal to $[-\rho g (C_L + C_{D_\alpha}) V]/(2W/S)$
Z_{δ_T}	$\frac{1}{m} \frac{\partial Z}{\partial \delta_T}$ (ft/sec ² -rad), the derivative of Z-force with respect to throttle displacement
α	Angle of attack (rad)
δ_T	Throttle displacement (usually rad, but may also be EPR or percent)
Δh	Change in aircraft height (altitude) with respect to trimmed altitude (ft)
ζ_d	Closed-loop damping ratio of height control mode (dimensionless)
θ	Aircraft pitch attitude (rad)
ρ	Air density (slugs/ft ³)

LIST OF SYMBOLS (Concluded)

ω_{c_d}	Glide slope loop crossover frequency (rad/sec)
ω_{c_u}	Airspeed loop crossover frequency ($\approx 1/T_u$) (rad/sec)
ω_d	Closed-loop natural frequency of height control mode (rad/sec)
ω_u	Bandwidth of airspeed regulation (rad/sec)
ω_h	Bandwidth of height regulation (rad/sec)

SECTION I

INTRODUCTION

Findings by the Flight Safety Foundation, the National Transportation Safety Board, and others indicate that human error is at least a major contributing factor in a very high proportion (80 percent or more) of civil transport, general aviation, and rotorcraft accidents. Finding ways to reduce the number and severity of human errors would thus appear to offer great promise for a significant reduction in accidents and improvements in aviation safety.

The proportional involvement of human errors in aviation accidents has been relatively stable in spite of many changes in the air traffic control system and typical cockpits. This does not necessarily mean that an irreducible minimum has been reached, however. Instead we appear to be on a plateau in understanding the quantitative details of just how the human elements contribute. To make a significant dent in error reduction requires a better appreciation for the sources and causes of human errors as they affect the total aeronautical transportation system structure.

Human errors in aviation tend to be treated in terms of clinical and anecdotal descriptions, however. For a more concrete identification of the sources of human error, one must strive to separate original underlying and contributing causes from the circumstantial causes cited in official investigative reports. Furthermore, if one is to attempt correction of the sources of human error, their cause-effect relationships must be better quantified and classified.

Meaningful quantification and classification requires a sound underlying and unifying foundation in terms of mathematical models which subsume existing evidence, permit the planning of experimental measurements, guide the interpretation of results, and serve as the basis for extrapolation of results to other circumstances. Reference 1 was prepared to fulfill this need for a sound foundation.

Based on the foundation in Ref. 1, Ref. 2 discussed the technical details of a variety of approaches for the measurement of human errors in the context of the national airspace system with primary emphasis on cockpit operations and procedures in part- or full-mission simulation. As one means to this end the National Aeronautics and Space Administration is planning a new Man Vehicle Systems Research Facility (MVSRF) for Ames Research Center. Recommended functional requirements and related priorities for the MVSRF are the subjects of this report.

A. REVIEW OF MVSRF REQUIREMENTS (REF. 3)

At present there is no national capability to support the flight simulation studies which are necessary for identifying and correcting the sources of human error associated with current and future air carrier operations*. The Man Vehicle Systems Research Facility is intended to address at least three issues requiring high operational fidelity in aviation safety research:

1. Full mission/full crew/multi-aircraft/air traffic control (ATC) interactions in general,
2. Crew/avionics, crew/crew, and crew/ATC interactions which are design specific, and
3. Advanced technology cockpits and man-machine relationships therein.

Major investigations of these issues will have as basic purposes the enhancement of flight safety and improved performance — in essence the reduction of human error.

Meeting these overall objectives will require research on critical human factors issues that are involved in:

* A national facility survey is provided in Ref. 4.

1. Development of fundamental analytical expressions of the functional performance characteristics of both the air-crew and ground crew;
2. Formulation of design criteria and principles, from the human factors perspective, appropriate to flight systems and operational environments of the future;
3. Integration of new subsystems and procedures such as electronic displays and automated avionics and controls into contemporary flight and traffic control scenarios; and
4. New training technologies that will be required by the continued technical evolution of flight systems and the operational environment.

The MVSREF will consist of two commercial transport aircraft cockpits designed to accommodate pilot, copilot, flight engineer, and observer. Although each cockpit will be on a fixed base, provision for the future incorporation of motion bases will be considered. The facility will also include a functional terminal area ATC capability and an interactive computer-generated external visual scene for each cockpit. These principal system components will provide a high degree of fidelity with particular attention being devoted to the human factors aspects of the simulations. One cockpit will be a fully functional representation of a contemporary commercial transport aircraft flight deck; it will be called the current technology flight deck. The other cockpit will be provided with a programmable array of all-electronic computer-generated display systems in place of the usual complement of electromechanical displays. This second cockpit may be configured to represent flight decks of future aircraft; it will be called the advanced technology flight deck.

Important aspects of the simulation facility will be: independent simultaneous operation of both cockpits in the same air space; provision of navigation and communication signals; two or more interacting aircraft; weather effects; sound effects; and the capability for initiating, monitoring, and controlling various system malfunctions and failures — all with a high degree of operational fidelity. A computer laboratory for overall control of the simulation, solution of the aerodynamic equations,

simulation of the effects of malfunctions and failures of aircraft systems, and collection and systematic analysis of simulation and performance data will be included within a new building to house the facility at Ames Research Center.

B. FUNCTIONAL ORGANIZATION OF THE FACILITY

Figure 1 portrays the overall functional organization of the MVSRF as defined in Ref. 3 and updated in Ref. 5. There are three main functional subdivisions within the facility, viz., the current technology flight simulation (shown at the left side of Fig. 1), the air traffic control simulation (shown in the center of Fig. 1), and the advanced technology flight simulation (shown at the right side of Fig. 1). More details of each of these functional subdivisions will be shown subsequently in Figs. 2, 3, and 4 adapted from Ref. 5.

Two host digital computers are planned to solve equations of motion for each of the flight simulations, to model avionics and aircraft systems, to provide computer-generated scenes and displays, to implement data collection, to control input/output operations among the facility subsystems, and, in general, to control each independent simulation. A separate digital computer is planned to perform simulation for the air traffic control function. A program development capability is also planned together with sufficient hardware and software communications to interconnect all computation system components.

System software will be required to support high level and assembly level language processing as well as program editing and debugging. A nominal set of program modules will also be required for each simulation. The set of program modules will include flexible aerodynamic models, as well as driver modules, for each of the facility subsystems under control by the simulation computer(s).

Having completed this overall view of the facility organization in Fig. 1, we shall now examine more details of the current technology flight simulation requirements.

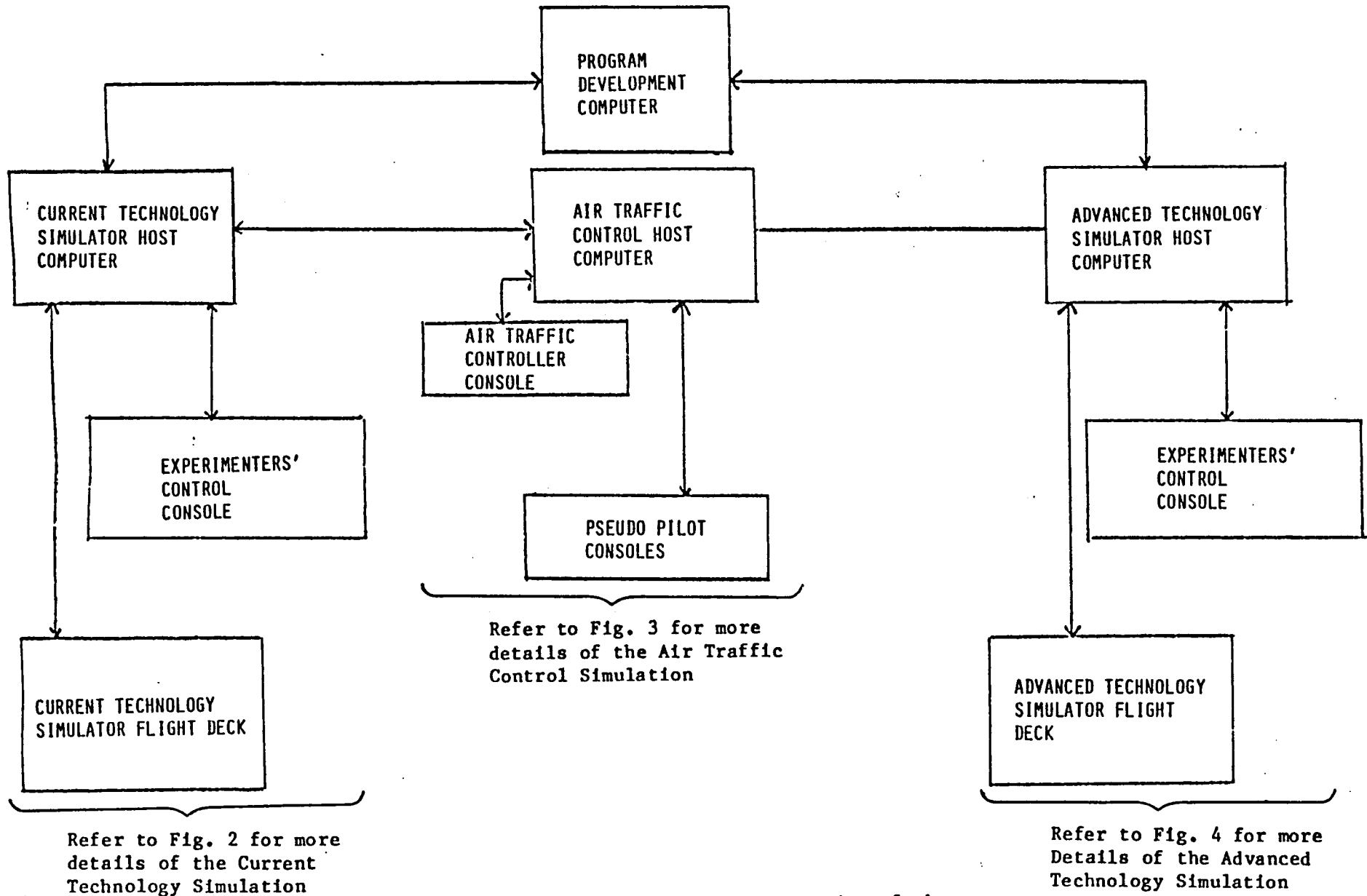

Figure 1. Overall Functional Organization of the Man-Vehicle Systems Research Facility (MVSRF) (Adapted from Ref. 5)

1. Current Technology Simulation (Fig. 2)

a. Flight Deck and Aircraft. The stated purpose of the facility is to reproduce with high operational fidelity all of the mission functions perceived and performed by each crew member throughout normal and abnormal flight profiles. Phases of the flight profile to be simulated include: filing of flight plans, preflight checkout, taxi, takeoff, climb, cruise, descent, holding, approach, landing, and final roll-out on the runway. This stated purpose does not necessarily mean that the facility must imitate all of the equipment involved. Nevertheless, as in the training community, the identical elements theory of Thorndike will likely be invoked for the current technology flight deck and the various mathematical models of the physical functions involved in the flight simulation. This is because of the importance (for studying the causes of human error) which is vested in the capability for initiating, monitoring, and controlling various flight and ATC system malfunctions and failures in the MVSRF. Reverse transfer of training (from flight experience to the MVSRF) is thus very important among flight crew members who will participate in full mission simulations. Reverse transfer is believed to be assured by providing a current technology flight deck which is functionally identical to that in a contemporary jet transport with which a significant portion of the airline pilot population has experience.

Likewise, because of the importance attached to studying the causes of human error, access to "initial condition," "hold," or "reset" control over the simulation should not be provided within the flight deck, thereby denying to the crew one means for concealing human error in the simulator.

Shown at the top of Fig. 2 is the current technology simulator host computer in which mathematical models of the aircraft and its flight system functions will be programmed. Table 1 lists the principal functions which are recommended for simulation in current technology host computer.

Figure 2 also shows the relationships among the host computer, the current technology flight deck, and the experimenters' control console via the input/output (I/O) subsystem and its satellite computer. References 3 and 5 have made preliminary estimates of the I/O subsystem requirements to

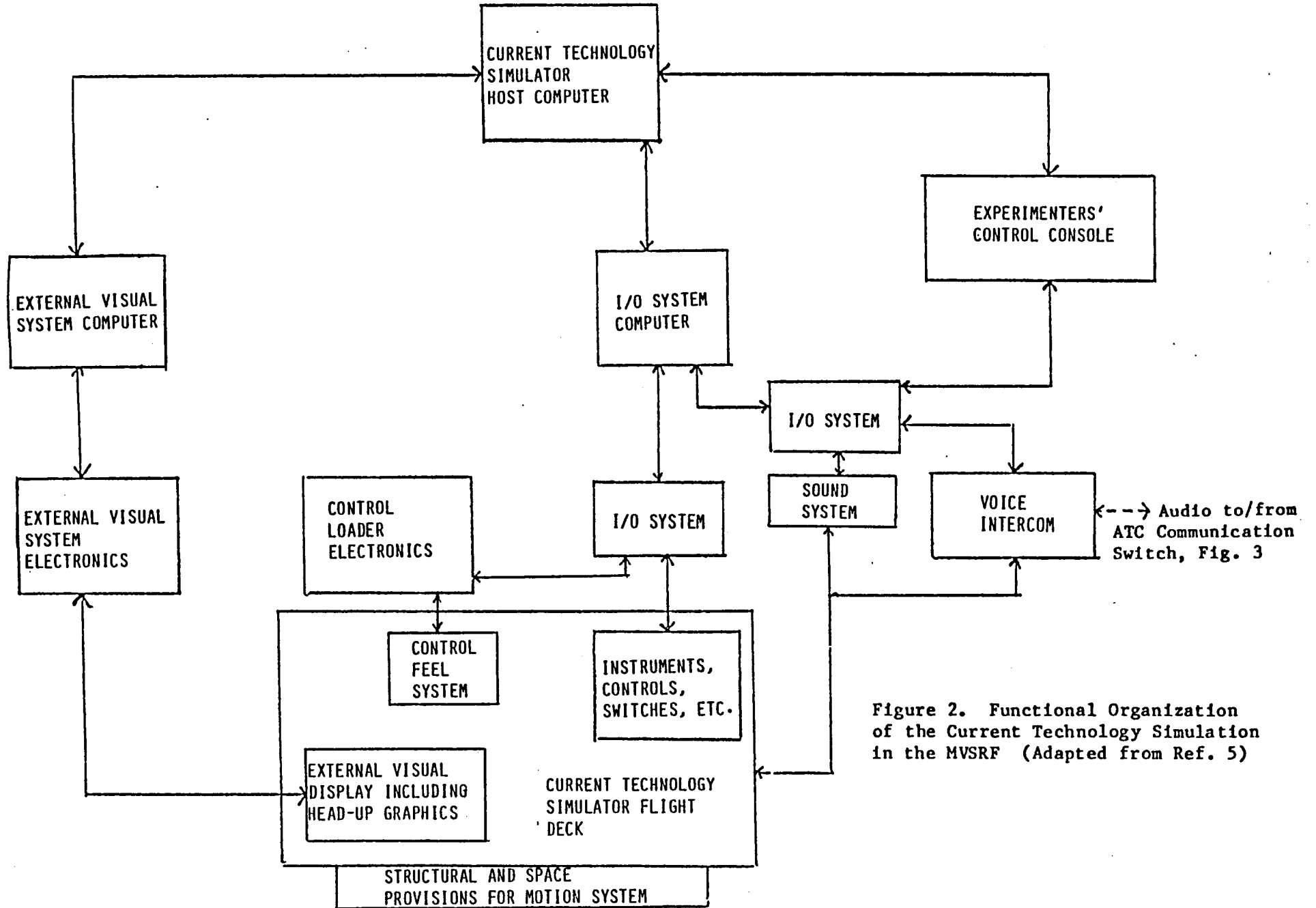

Figure 2. Functional Organization of the Current Technology Simulation in the MVS RF (Adapted from Ref. 5)

TABLE 1

FUNCTIONS RECOMMENDED FOR THE CURRENT TECHNOLOGY
FLIGHT SIMULATION OF A COMMERCIAL TRANSPORT

(Adapted from Ref. 5)

A. Airframe Kinematics, Aerodynamics, and Propulsion Dynamics

Mathematical models throughout flight profile, including ground taxi, takeoff, landing, and roll-out
External visual scene generation outputs, including provision for head-up display outputs
Instrument outputs
Flight control loader outputs
Flight and propulsion control inputs
Configuration control inputs
Steering and braking control inputs

B. Aircraft System Operations

Altitude transponder
Air conditioning and pressurization (environmental)
Air data
Automatic flight
Auxiliary power unit
Braking
Caution advisory
Communications
Electrical
Engine instruments
Fire protection
Flight control
Flight instruments
Flight management
Fuel
Hydraulic
Ice and rain protection
Landing gear
Navigation, including landing guidance
Nose wheel steering
Pneumatic
Propulsion and control thereof
Sound, including aural warning advisory
Warning advisory, visual
Weather radar (requires graphics display planned only for advanced technology simulation)

accommodate the large number of switches, indicators, instruments, and controls in the current technology flight deck exclusive of most circuit breakers. Total estimated requirements from Ref. 5 are shown in Table 2. The directions "in" and "out" in Table 2 are to be interpreted with respect to the I/O subsystem computer in Fig. 2. Only 32 bits of the discrete channel requirements are devoted to circuit breakers.

b. Experimenters' Control Console and Data Acquisition. This station will provide for set up, checkout, monitoring, and control of the simulation by means of status and performance data displays, selected instrument repeaters, closed-circuit video repeaters, computer terminals, and programmable multifunction touch panels and keyboards.

It should be possible for the experimenter to introduce failures of the major aircraft systems independently in each simulation. Specific mode and timing of the failures should be at the discretion of the experimenter. Routine access to all simulation variables should be provided while in operation.

It should likewise be possible to record digitally all data descriptive of the simulated flight envelope and aircraft system functions for an entire aircraft mission as well as selected subsets of crew procedures and behavioral data. Means should also be provided to retrieve and display selected channels of data, either for previously stored data or in real time. Archival data recording options should include hard copy, strip charts, and magnetic tape. Provision should be made to record routinely a full range of simulation variables without special operator actions such as manually loading tape decks while the experiment is in progress. The data to be recorded should be selectable in advance from the experimenters' terminals. Technical approaches for the measurement of human errors are discussed in depth in Ref. 2.

Three additional functional capabilities are shown in Fig. 2, viz., the external visual scene generation, sound generation, and voice intercommunication subsystems. Excerpts of the functional descriptions of these three subsystems follow from Ref. 3.

TABLE 2

NUMBER AND TYPE OF SIGNALS FOR THE MVSRF I/O SUBSYSTEM (From Ref. 5)

Type of Signal	Current Technology Flight Simulation		Advanced Technology Flight Simulation		Total*
	Flight Deck	Other†	Flight Deck	Other‡	
Analog Out (DAC)	To Flight Deck 240	58	13	22	333
Analog In (ADC)	From Flight Deck 40	15	37	0	92
Discrete and Digital In (Bits)	From Flight Deck 945 (32 are circuit breakers)	61	385	35	1426 bits
Discrete and Digital Out (bits)	To Flight Deck 553 (32 are circuit breakers)	155	188	98	994
Synchro In	From Flight Deck 6	0	0	0	6
Synchro Out	To Flight Deck 10	8	0	0	18

* Both flight decks can be run simultaneously if all I/O signals between flight decks and host computers are independent.

† Includes control loader, sound subsystem, experimenter's control console, and provisions for motion base drive signals.

‡ Includes sound subsystem, experimenter's control console, and provisions for motion base drive signals.

c. Visual Scene (From Ref. 3). "The scene generator will be a computer generated image (CGI) system. It will store a data base consisting of, at minimum, two terminal areas and a representation of enroute visual conditions so that complete aircraft missions may be simulated, including roll-out and taxi and the final approach and landing. The scene generator should be capable of generating other aircraft in the visual field and a variety of visual weather types, ceilings, and reduced visibility conditions. It should have the growth capability of displaying textured surfaces as well as points of lights, so that the visual conditions of night, dusk, and eventually day may be recreated. Several levels of visual occlusion should eventually be provided so that three-dimensional structures may visually block one another, an important element in visual depth perception and in producing a realistic visual illusion.

"Two display systems will be provided, one for each of the simulator cabs. Each system will consist of two cathode ray tubes (CRT) with collimating optic units, mounted in front of the pilot's and first officer's seats. Each display unit will provide a 45 deg wide by 35 deg high field of view and a virtual image at optical infinity. It is anticipated that specific research projects in the future may require additional field-of-view capability, e.g., side window views for traffic detection, collision avoidance, and complex or curved approaches. For this reason, an important capability of the visual system is that of modularity; it must be possible to augment the basic system in the future to provide more visual channels." (Ref. 3)

d. Cockpit Interior Sound Generation System (From Ref. 3). "It is intended that the cockpit noise generation systems meet the requirements of both high fidelity and flexibility. Sounds from a variety of sources within and outside the aircraft will be provided: slipstream noise, the noise of each turbofan engine, including jet and turbomachinery noise, air conditioning noise, landing gear actuator, auxiliary power unit (APU) and other hydraulic system noise, runway rumble noise, and aural warning sounds. Sufficient flexibility will be provided in the noise generation systems such that the characteristic sound of engine and other system malfunctions may be reproduced for the flight crew.

"Both discrete and analog signals from the host computer systems will be required to provide these sound generation systems with the appropriate aircraft parameters. For example, slipstream noise varies with airspeed and turboprop engine noise varies continuously as a function of engine rpm and thrust level. These signals will be of the analog variety. As many as 15 separate aural warning signals are provided in current technology transport aircraft cockpits. These sounds are typically acoustically simple: tones, horns, buzzers, etc. These aural warnings, landing gear actuation, and other transient or intermittent noises will be controlled by discrete signals from the computer I/O systems. The overall volume level in each cockpit will be controllable from the experimenter's console." (Ref. 3)

e. Voice Intercom (From Ref. 3). "The voice intercom system will provide flexible multi-channel voice communications for the various personnel involved in the simulation. Communication stations include aircraft simulator flight decks, ATC simulators, simulation operation, and experimenters' control, together with automatic interconnection for simulated navigation aids and weather information.

"In the simulator flight decks, the intercom system will be designed to simulate radio links for such functions as air traffic control sectors, navigation aids, and weather information. To the pilots it will appear that they are selecting radio frequencies on transceivers for communications with the various ground facilities.

"Navigation aids and weather information will be recorded on updatable endless log tape recorders. The pilots will be connected to these recordings when they select the proper frequencies.

"The ATC simulator will have stations for air traffic controllers, pseudo-pilots, and experimenters. The voice intercom for the air traffic controllers will be designed to operate in a manner similar to actual ATC installations.

"The experimenters and simulator operators will be able to monitor, intervene, and control the voice intercom. A multi-channel audio tape recorder will also be connected to the system so that a permanent record of the audio part of the simulation can be made." (Ref. 3)

This concludes a review of functional requirements for the current technology simulation. In the next topic we shall outline functional requirements for the air traffic control simulation.

2. Air Traffic Control Simulation (Fig. 3)

Within the context of full-mission simulation experiments involving commercial transports, one of the essential ingredients is simulation of interacting air traffic and the necessary communications with the responsible air traffic controllers. Ames Research Center has an operational ATC simulation facility which has been connected via telephone link to FAA NAFEC simulations. Although the ATC display processor, the ATC visual display-audio communication interfaces, and the pseudo-pilot audio-control interfaces exist at Ames Research Center as shown in Fig. 3 within the  symbols, the facility lacks a dedicated host computer system (center of Fig. 3) which is needed for long-duration full-mission simulation. Consequently the MVSRF design group has invited the M.I.T. Flight Transportation Laboratory to recommend functional requirements for an independent ATC simulation facility which is capable of servicing full mission simulation. The results are given in Fig. 3, together with the list of requirements in Table 3.

The advantages of this approach (from Ref. 3) are three-fold: (a) some of the projected ATC experiments can be conducted independently of the MVSRF, (b) traffic generation software developed independently for ATC studies can be incorporated in full-mission simulation experiments, and (c) the traffic generation function itself, which can be computation-intensive, will not compete for computation resources within either the current or advanced technology simulation hosts. The ATC simulation facility will not be discussed further in this report.

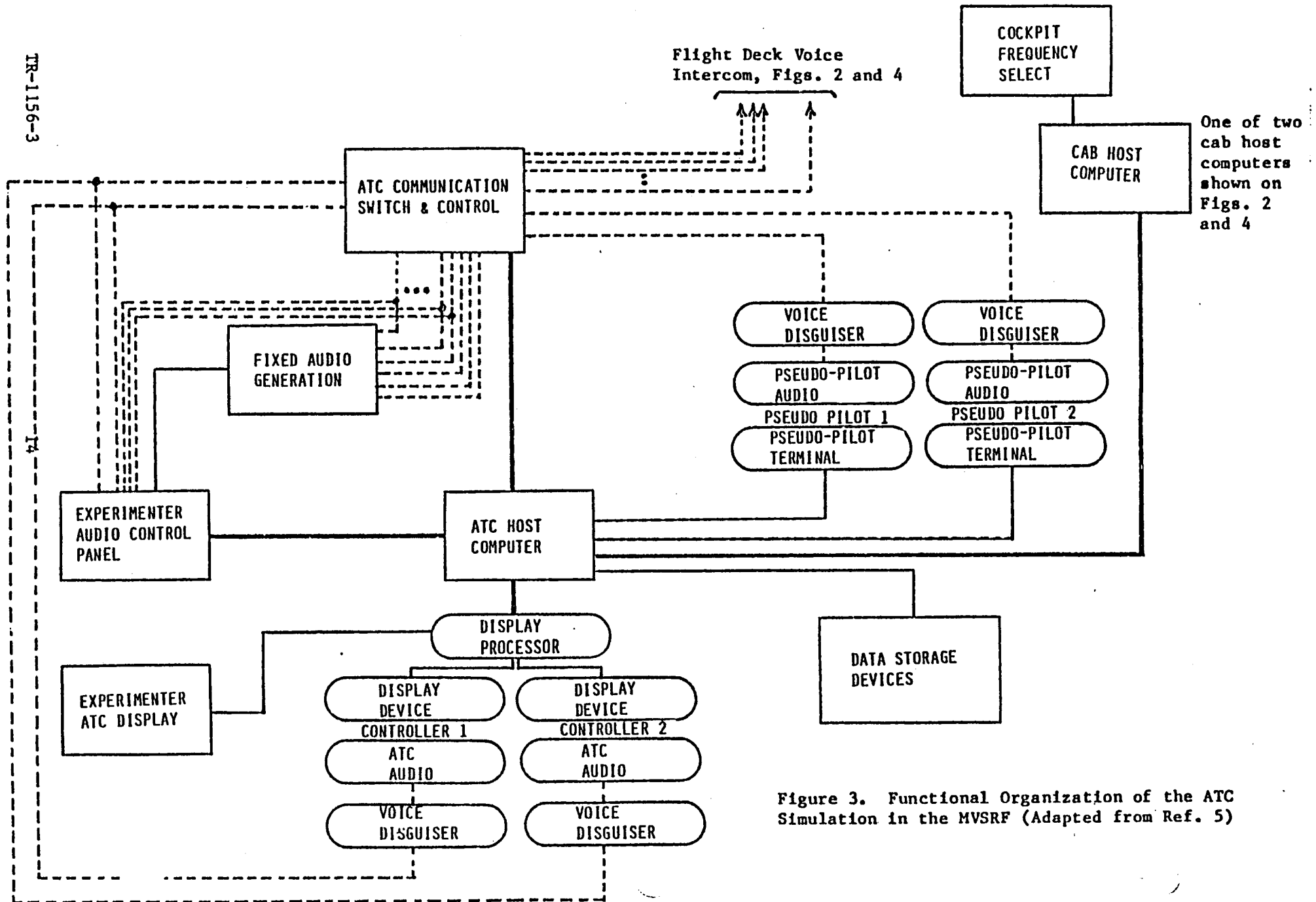

Figure 3. Functional Organization of the ATC Simulation in the MVS RF (Adapted from Ref. 5)

TABLE 3

FUNCTIONS RECOMMENDED FOR THE AIR TRAFFIC CONTROL SYSTEM
SIMULATION IN THE MVS RF

(From Ref. 5)

- Generate Pseudo-aircraft at prespecified points and time
- Provide controllers with information needed to control traffic
- Provide control via voice or data link communication to piloted and pseudo-aircraft
- Allow pseudo-pilots to navigate pseudo-aircraft via keyboard entry
- Generate aircraft and piloted aircraft positions as a function of: Commands, aircraft dynamics, and wind environment
- Generate ground track data on pseudo- and piloted aircraft positions as perceived by surveillance radar
- Provide host computers of piloted simulators with traffic data required to drive onboard traffic displays and visual scene
- Manage and distribute available ATC information (ATIS, weather) via voice and/or digital datalink
- Dynamically change ATC sectors (airspace, nav aids, pseudo-traffic) according to script and position of piloted aircraft
- Collect performance statistics for on-line processing and display
- Perform advanced ATC management functions: runway scheduling, flight path generation, collision avoidance, and resolution.

In the next topic we shall examine functional requirements for the advanced technology flight simulation.

3. Advanced Technology Simulation (Fig. 4)

The advanced technology simulation, by definition, can be liberated from following the precepts vested in the identical elements theory of Thorndike. The cost of "liberation" will inevitably be more substantial flight crew training requirements for full-mission simulations employing advanced technology. Our experience in Ref. 6 reflected substantial training requirements even for part-mission simulation, and the MVSRF experimental planning workshop also recognized this fact in Ref. 7.

Shown at the top of Fig. 4 is the advanced technology simulator host computer in which mathematical models of the aircraft and its flight system functions will be programmed. Table 4 lists the principal functions which are recommended for simulation in the advanced technology host computer.

Figure 4 also shows the relationships among the host computer, the advanced technology flight deck, and the experimenters' control console via the input/output (I/O) subsystem and its satellite computer. Reference 5 has made preliminary estimates of the I/O subsystem requirements to accommodate the advanced technology flight deck exclusive of most circuit breakers. Total estimated requirements from Ref. 5 are shown in Table 2. The I/O requirements for the advanced technology simulation are reduced by virtue of the substitution of computer-graphics in place of the large number of individual switches, indicators, instruments, and controls in the current technology simulation.

a. Flight Deck. Excepting the head-up display, all primary flight, navigation, aircraft system, and status advisory displays will be generated on flat panel displays or cathode ray displays by a computer-graphics systems shown in Fig. 4. The configuration and content of these primary displays will be varied from one experiment to another. Typical examples of display layout and content may be found in Refs. 5 and 8. Flight management, command, actuation, status, and advisory information will be generated and presented in this manner.

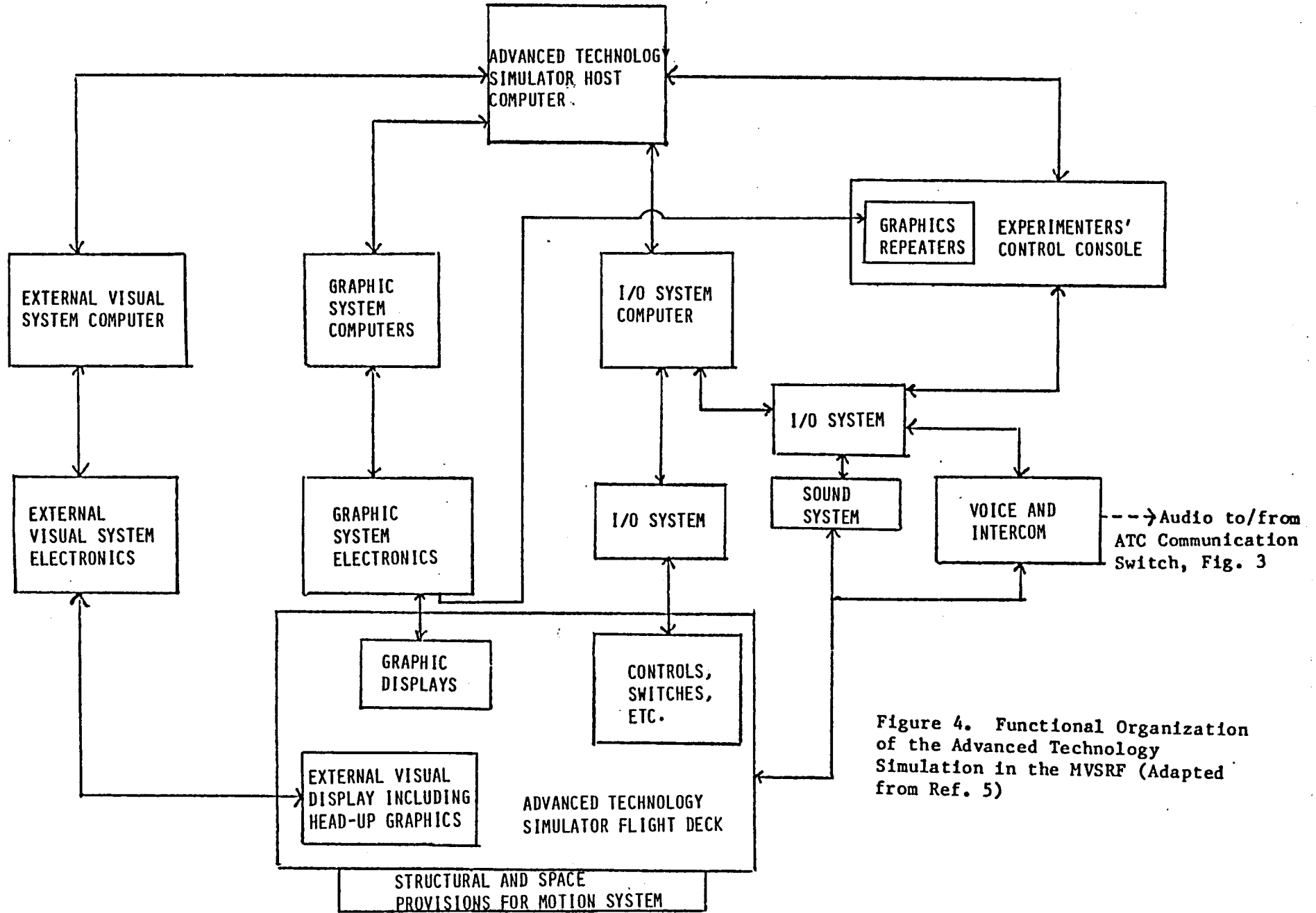

Figure 4. Functional Organization of the Advanced Technology Simulation in the MVSRF (Adapted from Ref. 5)

TABLE 4

FUNCTIONS RECOMMENDED FOR THE ADVANCED TECHNOLOGY FLIGHT SIMULATION
OF A COMMERCIAL TRANSPORT

(Adapted from Ref. 5)

A. Airframe Kinematics, Aerodynamics, and Propulsion Dynamics

Mathematical models throughout flight profile, including ground taxi, takeoff, landing, and roll-out
External visual scene generation outputs, including head-up display outputs
Primary flight display outputs (EADI)
Integrated navigation display outputs (EHSI)
Status advisory display outputs from aircraft system operations
Primary engine display outputs
Control surface display outputs
Control display unit inputs/outputs
Flight control loader outputs
Flight and propulsion control inputs
Configuration control inputs
Steering and braking control inputs

} Outputs for
Graphics
System

B. Aircraft System Operations

Air conditioning and pressurization (environmental)
Air data
Automatic flight
Auxiliary power unit
Braking
Collision avoidance
Communications
 Voice
 Data link
Electrical
Fire protection
Flight control, including stability and control augmentation
Flight management
Fuel
Hydraulic
Ice and rain protection
Landing gear
Monitoring, alerting, and warning (including caution advisory)
Integrated navigation and guidance
Nose wheel steering
Pneumatic
Propulsion and control thereof
Sound, including aural warning advisory
Weather radar

b. Experimenters' Control Console and Data Acquisition. These functions will be similar to those described previously for the current technology simulation, except that instrument repeaters will no longer be required, since video repeaters will accommodate all displays as well as the external visual scene.

Three additional functional capabilities are shown in Fig. 4, viz., the external visual scene generation (including the head-up display graphics), sound generation, and voice intercom subsystems. The functional descriptions of these subsystems remain substantially the same as described previously for the current technology simulation.

c. Visual Scene. The head-up display graphics will be added, and the field of view of the external visual scene will be increased to accommodate visual traffic detection and collision avoidance experiments outside the forward "tunnel" field of view provided in the current technology simulation.

d. Cockpit Interior Sound Generation (From Ref. 3). "Cockpit alerting and warning system research will comprise an important area of utilization for this advanced facility. Consequently, it is required that a subsystem be provided which can introduce both spoken and coded warning signals into either the advanced technology cockpits upon command from the host computer system. Otherwise the cockpit interior sound generation function will be similar to that described previously for the current technology simulation.

e. Voice Intercom. This function will be similar to that described previously for the current technology simulation.

This concludes our introduction to the functional organization of the MVS RF. From this introduction it should be clear that careful planning by NASA has evolved the functional organization to an advanced state of readiness for more detailed investigation of subsystem functional requirements in the light of critical operational scenarios, to which we turn next.

C. CRITICAL OPERATIONAL SCENARIOS

An essential prerequisite to recommendation of more specific subsystem functional requirements for the MVSRF is a thorough review of the anticipated needs. Our primary method for accomplishing and summarizing this has been to prepare a table of critical operational situations requiring investigation of causes of human error. The result is given in Table 5, which lists flight phases and piloting tasks required for both conventional commercial, and STOL transport aircraft.

The mission phases for both types of aircraft emphasize the criticality of terminal and near-terminal operations wherein both piloting and air traffic control procedures are prone to human error. Normal cruising flight also involves climbing, rough air disturbance regulation, and descent procedures which may be vulnerable to crew complacency induced by automation. Finally several emergencies are listed which merit further investigation with an element of surprise. This last use of the MVSRF is most important and constitutes some of the most demanding situations in several respects. We have enclosed certain cells of Table 5 within bold outline to emphasize their criticality from the standpoint of their impact on the functional requirements of the simulation.

After reviewing Table 5, attaching weighting factors to the importance of the aforementioned phases and tasks, and considering the various simulation elements (i.e., the computer, instruments/displays, visual, motion, and control systems) we have listed in Table 6 several critical operational scenarios which emerged to constrain the design of these simulation elements. The "critical requirements and remarks" column represents a concise summary of some of the issues to be discussed in the subsequent sections of this report.

TABLE 5

CRITICAL OPERATIONAL SITUATIONS REQUIRING SIMULATION
FOR THE PURPOSE OF INVESTIGATING HUMAN ERROR

Flight Phases	Piloting Task	Transport Aircraft	
		CTOL	STOL
Terminal Operations	Takeoff	Lift-off and rotation; engine out	Maximum power jump; engine out
	Landing		
	Beam Acquisition	Beam Overshoots	ATC Procedures; curved approaches
	Approach	ICAO Cat. II, VFR; IFR III; DLC; ETA Control	Curved approach; VFR, IFR; Steep descent; DLC, TVC*
	Breakout and flare	ATC procedures	ICAO Cat III; DLC, TVC
	Decrab (touchdown) rollout	ICAO Cat. III	Crosswinds
	Taxi and docking	ICAO Cat. III-B,C	ICAO Cat. III-B,C
Near Terminal Operations	Go around	Energy management; VFR, IFR Procedures	Energy management; VFR, IFR Procedures
	Close-in navigation	IFR and ATC procedures; traffic detection	IFR and ATC procedures; traffic detection, curved course, steep descent
	Noise abatement or minimum exposure	Steep turns, minimum noise takeoffs	Curved course, steep descent, minimum noise
Normal Cruising Flight	Holding	ATC procedures; FAA holding pattern in wind; fuel dump	ATC procedures; FAA holding pattern in wind; configuration change; engine out
	Climb	FAA noise profile	FAA noise profile, curved course
	Cruise	ATC procedures; automation crew complacency; crew fatigue; energy management; altitude control; course control; waypoint overshoots; RNAV	ATC procedures; automation crew complacency; crew fatigue; energy management; altitude control; course control; waypoint overshoots; RNAV
	Rough air disturbance regulation	C.A.T; gust upset; wind shear	Gust upset; wind shear
Emergencies	Descent	TOD overshoots; (see Hi-q and/or Hi Mach)	TOD overshoots; (see Hi-q and/or Hi Mach)
	Hi-q and/or Hi Mach	Fast descent (tuck); PIO; engine out	Fast descent (tuck); PIO; engine out
	Engine-out management	Asymmetric conditions; takeoff; low speed; hi-q	Asymmetric conditions; takeoff; low speed; hi-q
	AFCS failures management	Hardover	Hardover
	Damage management	Collision; structural failure; fire	Collision; structural failure; fire
	Aircraft/ATC system failure management	Distraction from flight management in any phase	Distraction from flight management in any phase
	Collision avoidance	VFR; IFR; ATC procedures; response to warning; evasive maneuvers; structural failure; aerodynamic stall	VFR; IFR; ATC procedures; response to warning; evasive maneuvers; structural failure; aerodynamic stall

* Configuration change; ETA control; engine out.

TABLE 6

SOME CRITICAL OPERATIONAL SITUATIONS WHICH WILL
CONSTRAIN THE DESIGN OF SIMULATION ELEMENTS

Critical Operational Situations	Constrain These Simulation Elements	Critical Requirements and Remarks
"Full Mission Simulation"	Computer: Instruments/ Displays:	Kinematics and guidance calculations over long ranges and times. Time-Varying aircraft trim, coefficients, and controls; 6 DOF. Failure effects in all aircraft systems. Realistic and complete instrument, avionics, and navaid complex for all crew members.
ICAO Categories II and III Landing and Terminal Operations	Computer: Instruments: Auditory Cues: External View:	Traffic generation and air traffic control simulation; collision avoidance. Failure effects in all aircraft systems. Use of HUD or HDD simultaneously with instruments. Realistic Category II and III instrument, avionics, and navaid complex for all crew members. Engine whine and aero noise affect throttle handling. High acuity view of approach and runway; fog simulation. Modest field of view (± 25 deg okay). Visual scene response delay > 40 msec may compromise fidelity in takeoff, breakout flare, decrab, rollout, taxi, and docking. Very smooth presentations required.
VFR Terminal Area	External View:	High acuity wide field needed for traffic detection; cloud simulation.
VFR Approaches	Motion Cues:	Cue induced motion cues are important for compensatory regulation. Frequency response critical; travels can be modest via attenuated inputs or by shaping input to dominant frequency region.
Engine Failures; Hardover Control Failures; Aerodynamic Stall	Motion Cues:	Alerting cues are important; combination of rotary and linear. Travel versus washout depends on cue duration. Buffeting cues are important (stall margins).
STOL Maneuvers (e.g., curved approaches, steep descents, crosswind landing, transition maneuvers)	Computer: External View: Pilot's Controls:	Time- and configuration-varying, 6-DOF, coupled, NL aerodynamics; $V_{inertial} \rightarrow 0$ (landing into steady wind) Complex terrain features required for height and direction cues. Large field of view required (± 45 deg; more if $V_{inertial} \rightarrow 0$). High acuity is desirable in foveal region; parafoveal field can be crude. Large rotation and crab angles with respect to line-of-sight or path. New piloting techniques require diverse mix of primary controls (e.g., thrust vector)

D. ORGANIZATION OF THE REPORT

Section II attempts to clarify the notion of functional fidelity as it applies to flight simulation and concludes with suggested criteria for fidelity of some of the elements with which we are concerned. Particularly in the cases of the visual field and motion systems, the criteria are deficient and merit considerable research, per se.

Section III discusses visual field simulation and Section IV, motion cue simulation. Section V treats the vehicle and environmental models, and Section VI, computational considerations. Section VII offers recommendations for organization of the software, based on our experience. Section VIII addresses crew stations and Section IX, the experimenter's console. Section X offers some suggestions for facility integration, checkout, scheduling, operation, and staffing. Section XI presents conclusions and recommendations and is followed by the list of references and supporting appendices.

SECTION II

FUNCTIONAL FIDELITY

A. DEFINITIONS

1. Understanding what is Meant by Fidelity and Validity

Simulators are already used in flight research and training for three main reasons:

- Simulators involve lower costs to buy and operate than an aircraft
- One can safely expose untrained subjects to potentially dangerous situations
- One can control the variables and measure the results easier in a simulator than in the real environment.

All such applications presuppose that there is a positive transfer of training between the simulator and the "real-world" situation when the "fidelity" of the simulation subsystem and the "validity" of the simulation become "adequate" in some sense. Reference 9 has discussed these issues in depth. Whereas the validity issue addresses directly the transferability of simulator results to the flight situation, the fidelity issue addresses the adequacy of perceptual effects and their consequent pilot responses induced by the simulator as a result of, for example, cockpit (crew station), visual, motion, aural, and computation subsystem engineering and construction. "If minimum fidelity requirements are not met for economic reasons, the validity of the total simulation may be jeopardized. In this sense, the two issues are interrelated, and the burden of proof falls on the research community to justify necessary improvements in fidelity which stem from established requirements in validity. The fundamental problem is to assess the extent to which subsystem engineering improvements promote increased psychological (including psychomotor) realism." (Ref. 9)

We shall begin by considering some ideas about simulator fidelity which are useful for our purposes. Reference 10 presents a discussion of fidelity which distinguishes two main "types" of fidelity: objective fidelity and perceptual fidelity.

Objective fidelity (or in Ref. 11, engineering fidelity) is the degree to which the simulator reproduces measurable aircraft states or conditions. To ensure perfect objective fidelity, elaborate mathematical models of aircraft are frequently developed using actual wind tunnel data, detailed flight control system diagrams, replication of aircraft cockpits and control feel systems, and anything else affordable which may be regarded as the last word in definition of the actual aircraft. In striving for visual field fidelity, the training simulation community has usually tried to describe (and to specify) the engineering fidelity of a visual simulator subsystem in terms of the functional attributes in Table 7. In terms of motion fidelity, perfect objective fidelity would correspond to a one-to-one duplication of inertial-based displacements, velocities, and accelerations in each axis of freedom, a limit of perfection which only total in-flight simulation can achieve.

Unfortunately, methodologies have not been developed to determine with high confidence the interactive influence of (simulator) subsystem engineering fidelity on overall (simulator) system validity as it has been defined. Recently such methodologies have undergone more careful scrutiny and some attempts have been made (notably at the University of Illinois, Institute of Aviation) to establish the validity of various ground-based flight simulators. The results are partially consistent and somewhat controversial, but generally support the well-proven fact that when all procedures, all aspects of the environment, and all cues are correct, then good training results. The problem remains to quantify how far the cues can deviate from reality and still provide cost-effective simulation for the MVSRF.

Perceptual fidelity is the degree to which subjects perceive the simulator to duplicate aircraft states or conditions. This type of fidelity is subject-centered and includes both psychological and physiological effects. We shall not, however, concede that perceptual fidelity is

TABLE 7

FUNCTIONAL ATTRIBUTES OF A VISUAL SIMULATOR

Field of view

Elevation
Azimuth

Image quality and fidelity

Static resolution	}	dependence on field of view and requirement for overlapping fields
Dynamic resolution		
Depth of field		
Brightness		
Contrast — monochromatic versus color		

Scene content — essential and desirable

Recognition thresholds for pattern information in detail and texture
Form, size, inclination, expansion, and rotation thresholds for
acceleration, velocity, and displacement control information
Special effects — heterogeneous fog, clouds, sea spray, dust
Artificial cues
Peripheral visual displays
Independent synthetic landing monitor displays in a head-up
format
g-seats and g-suits

Image generation techniques

Scale models with movable television camera
Computer-generated
Calligraphic
Raster graphic
Electronically-generated calligraphic
Cinematographic
Point-light source

Image presentation technique

Real — screen shape, viewing distance, front or rear projection
Virtual — exit pupil size, shape, hyperfocal distance, binocular
disparity

Movement performance

Rotational	}	acceleration, velocity, and displacement extrema and thresholds
Translational		
Dynamic errors		
Jitter		
Flicker		
Update rate or visual lag		

either unmeasurable or unquantifiable. In fact, we shall offer some recommendations, based largely upon Ref. 2, for ultimately quantifying perceptual effects.

To the extent that the human operator's perception can be explained in rational terms, it is possible to merge the ideas of objective and perceptual fidelity. For example, since the human vestibular system can be described in terms of effective washouts, lags, and thresholds, then it is possible to apply the same objective metrics as one does to a mechanical motion base platform, an electrical network, or an airplane equation of motion.

Another aspect of fidelity which needs to be addressed is that of induced pilot behavior. Reference 12 defines simulator fidelity as the adequacy of perceptual effects and their consequent pilot response behavior induced by the simulator. Furthermore, this behavior must be qualified by a specified task environment. The issue of behavior is, of course, central to learning and skill development. If the simulator cannot induce correct behavior, then its role in training is questionable. At the very least, failure of a simulator to induce certain features of correct behavior in a specific task environment should be duly noted.

2. An Operational Definition of Fidelity

We have arrived at a point at which it is possible to set forth a general definition of simulator fidelity which takes advantage of our growing knowledge of the pilot's perceptual mechanisms and induced behavior, the dynamics of the simulator components (electro-mechanical and electronic), and the specific flight tasks of interest.

Note that the means of viewing the simulator and the pilot, which is described above, allows for extensive but direct quantification. Our objective regarding fidelity is to establish a working definition which takes full advantage of such quantification.

Consider also that training is the development and refinement of a suitable control loop structure — the specific means by which a task is carried out. Further, training involves the reliance upon perceptual mechanisms appropriate to the given task.

Therefore an appealing approach to simulator fidelity is to focus on how the pilot carries out a particular task given the perception (or inferred perception) of necessary cues. Hence we would construct a quantitative comparison between simulator and flight of the combined induced behavior and pilot perception. This frees us from the notion that perfect fidelity is a one-to-one correspondence between simulator systems and the actual aircraft* — a practical impossibility anyway. Rather, perfect fidelity is characterized by the simulator pilot behaving in a manner appropriate to the aircraft situation. These ideas do not, in essence, vary from the various concepts of simulator fidelity mentioned earlier.

We suggest, then, that fidelity is the specific quality of the simulator which permits the pilot to execute successfully a given task as he would be accustomed in the actual aircraft. Execution of said task is simply the organization of perception and closure of all loops[†] made necessary by both the task requirements and the dynamics of the vehicle and subject to the information which is available. In order to close loops on the required states, cues corresponding to the states themselves must at least be defined, perceived, and recognized in terms of cardinal abstractions from the pilot's perceptual fields. This implies first the requirement that:

- The task variables have been defined for the pilot. Task variables include the specific purposes, assignments, and commands comprising the mission strategy, the

* This notion follows from the identical elements theory of transfer of Thorndike.

† Including those involving cognitive choices, descisions, and discrete activities as well as those involving more or less continuous psychomotor activities.

likely guidance media, the vehicle to be used, and the likely disturbances, intrusions, and counteractions to be expected throughout the mission profile. Task variables comprise all the system inputs and those vehicular elements external to the pilot which enter directly and explicitly into the pilot's assignment and affect the decision which he must make.

Second, this implies the requirement that:

- The feedback (and feedforward) cues essential to the task can be (a) adopted by the pilot and (b) discovered by the analyst. These are categorically called "essential feedbacks" in Ref. 13. The feedback cues actually selected by the pilot will correspond to the states which are both necessary and sufficient to satisfy the decision-making, guidance, and control needs and certain pilot-centered requirements.

The decision-making, guidance, and control needs are situation-specific. Satisfaction of these needs always involves the organization of perception and adoption of task-centered outer loops, with the addition of subsidiary inner loops and other axis crossfeeds as needed to promote the adoption of the outer loops in accord with the following pilot-centered requirements*. The feedback loops preferred are those which (Ref. 14):

1. Can be closed with pure gain equalization by the pilot.
2. Can tolerate a time delay which is characteristic of the appropriate modality.
3. Require the least scanning activity to perceive the feedback cue.
4. Permit great latitude in the pilot's adopted characteristics.

* The Successive Organization of Perception (SOP) theory of skill development is treated in Refs. 1, 14, and 15. Sheridan (Ref. 16) has attributed the cognitive organizing activities represented by SOP to a functional construct called the "metacontroller" within the cerebrospinal portion of the nervous system.

Third, this implies the requirement that:

- The cues corresponding to the essential feedbacks should be represented by coherent patterns* in the perceptual fields which the pilot has learned (or will learn) to recognize in flight. Each intrinsic pattern, in turn, must be sufficiently coherent in situ to exceed the pilot's threshold of recognition.

Fourth, this implies the requirement that:

- The cardinal features which comprise the patterns should present a perceived signal-to-noise ratio to which the pilot is (or will be) accustomed in flight.

Given the perceptual abilities of the pilot, there are four additional requirements regarding dynamic changes in cues corresponding to dynamic changes in the essential feedbacks. The change in cues or states must:

- Be large enough to exceed the perceptual thresholds (e.g., vestibular thresholds or visual acuity)
- Be quick enough to permit the closed loop bandwidths required (e.g., motion lags or visual update).
- Be sufficiently distortion free to permit correct compensation by the pilot (e.g., washout not too fast).
- Be sufficiently noise free so as not to require workload for processing, filtering, or reconstructing patterns of change (e.g., motion vibration level, picture jitter, or flicker should be minimized).

* Such coherent patterns have been called cardinal cues, abstractions, or features. Examples are discussed in Refs. 14 and 17-40.

Hence we have tied fidelity directly to perceived states and their characteristics in terms of:

Threshold

Quickness

Distortion

Signal-to-noise ratio

Each of these characteristics is, in turn, directly quantifiable in a variety of ways. For example, motion threshold is directly related to thresholds of the human vestibular system — although somewhat task dependent, nevertheless well researched quantities. Quickness is most likely tied to the control bandwidth required for a given task. Distortion may be as simple as specifying flatness of frequency response — it implies that the amplitude and shape of response are adequate. Finally, signal-to-noise ratio relates to ease of detection and can be established on an empirical basis.

It is important to recognize that the above concept of fidelity is based simply on the consideration of usable cues for a specific task. It is founded on the notion that pilot behavior and perception can be characterized in terms which are compatible with the simulator on one hand and the actual aircraft on the other. A summary of this concept of simulator fidelity is given in Table 8.

B. LEVELS OF SIMULATION

Research into the human error and skill retention problem will require some degree of simulation. Simulation is also essential for evaluating the operator-centered characteristics of individual displays, communication links, and controls in advance of operational test. Simulation offers, at present, the only way to measure crew workload under controlled (normal and abnormal) conditions. In turn, operator workload measures appear to offer a more sensitive discriminant than system error performance of incipient circumstances for human error.

TABLE 8

A SUMMARY DEFINITION OF SIMULATOR FIDELITY

SIMULATOR FIDELITY:

The specific quality of presentation of perceivable states in terms of characteristics which are essential to inducing correct psychomotor and cognitive behavior for a given task and environment.

WHEREIN:

Applicable states are chosen on the basis of specified task loop structure.

Characteristics of states are determined by their role in inducing correct behavior --- i.e., quantification of loop structure adjustments (tightness, compensation).

Several domains (e.g., time, frequency; deterministic, stochastic) can be used to express characteristics of applicable states in terms of convenient fidelity parameters.

Simulation provides a flexible and controlled environment for control-display studies. Unlike operational tests, simulations can be limited to include only those features of the controls and displays and of the operating environment that are directly related to the characteristics being investigated. This saves both time and money, since less equipment is required and more relevant data can be collected in a given period of time. Simulation also provides a means for controlling extraneous variables that are beyond practical control in operational tests. Environmental conditions, navigational aids, and operational procedures can be standardized and thus eliminated as factors contributing to the error variance in simulations.

As always, these advantages are accompanied by several problems. Vehicle models and models of the environment are developed as abstractions from the highly complex real world. As such, there are invariably differences between operator performance in simulators and in actual vehicles. Some of these differences can be reduced by intelligent selection of vehicle and environmental disturbance models, and the important aspects of the remaining differences can be minimized by careful selection of the questions to be answered by simulation testing. The simulation operating procedures can also have an effect on the human operator performance the airlines require the flight crew to be in full uniform during their simulations. Furthermore, the crew members know that failure to fly the simulator properly could cost them a high-paying job. These aspects greatly add to the realism of the simulation! In a research simulator the proper simulation of value (i.e., the worth or penalty) associated with the various system outcomes such as crashes, fuel or time loss, etc., is very important but difficult to achieve. For example the consequence of a crash to flight crew members in real life is probably death which would engender a strong aversion to any action that might lead to this consequence. In a simulation then, some similar drastic consequence should be substituted, for example, elimination of the crew from the experiment. When carried to the extreme, the simulation and experimental scenario should have high fidelity in certain respects in order to encourage a utility structure that is similar to real world motivations. For example

this might include flight decks, boarding areas, etc., that would attempt to evoke a mental set as close to real operational conditions as possible.

While simulations are superior to operational tests for studying selected aspects of control-display systems, simulations become inadequate as more and more complexities of the operating environment are required for the studies. The related issues, simulation validity* and subsystem fidelity†, have been discussed in the previous topic and in Refs. 9 and 42 through 47. The simulation could conceivably consist of almost anything within the spectrum ranging from abstract laboratory tasks to a full scale mission simulation. The desirability of various degrees of simulation has been discussed at length in the literature (e.g., Refs. 48 and 49) and the advantages and disadvantages of three levels of simulation are listed in Table 9.

The "missions" under consideration here involve commercial, corporate, and general aviation transportation within the national airspace system under the applicable Federal Air Regulations (FARs). The concomitant skills required of both flight crew and air traffic control specialists are therefore reasonably well defined and, except for reacting to specific failures and emergencies, most skills are fairly well rehearsed. Thus, because the nature of the intended research deals with detection and identification of low probability events, we must provide a qualified endorsement of the "full mission simulation" in Table 9. The qualifications are listed among the "con" factors in the "full mission simulation" column in Table 9.

For example, Ref. 3 anticipates that the MVSRF will conduct uninterrupted flight simulations lasting several hours — usually repeated on

* Validity in this context is defined as the transferability of simulator performance results to the flight situation. Typical quantitative measures of transferability are summarized in Ref. 41.

† Fidelity is defined as the adequacy of perceptual effects and their consequent pilot response (nature and timing) behavior induced by the simulator for a specified task environment. (Refer to Table 8.)

TABLE 9
COMPARISON OF THREE LEVELS OF SIMULATION

Full Mission Simulation	Part-Task Simulation	Synthetic Task Simulation
<p>Pro:</p> <ul style="list-style-type: none"> •Face validity •Motivating to test subjects •Can aid in system design <p>Con:</p> <ul style="list-style-type: none"> •Expensive •Formidable logistics in conducting experiment •Difficult to measure basic behavioral factors •Difficult to generalize results to new situations; task-specific •Difficult to make allowances for actual environment when it does not coincide with test environment •Workload difficult to measure without changing task •Very difficult and expensive to establish reasonable fiducial statistics for low-probability events •Formidable training requirements 	<p>Pro:</p> <ul style="list-style-type: none"> •Some face validity •Less expensive than full mission simulation to establish reasonable fiducial statistics for moderate-to-low probability events •More convenient experimental design •Less difficult to measure basic behavioral factors •Manageable training requirements •Offers a surrogate environment for inducing crew fatigue, prior to more complete simulation of terminal area operations. <p>Con:</p> <ul style="list-style-type: none"> •Difficult to generalize results to new tasks •Difficult to make allowances for actual environment when it does not coincide with test environment •Workload difficult to measure without changing task •Still difficult and expensive to establish reasonable fiducial statistics for very low probability events 	<p>Pro:</p> <ul style="list-style-type: none"> •Can design tasks to measure basic behavioral factors •Relatively inexpensive •Convenient experimental design •Can design low variability, highly sensitive tasks which allow for efficient experimental design leading to reasonable fiducial statistics for specific tasks •Can make allowances for more difficult environment •Workload measurements can be part of tasks •Can be configured to have face validity for a general range of tasks •Simplest training requirements <p>Con:</p> <ul style="list-style-type: none"> •May have lower face validity for specific mission simulation •Possible low motivational value

successive days with different flight crews and ATC specialists. To conduct such simulation experiments will also require fixing schedules for experimenters and facility support personnel. Notwithstanding the issues of facility reliability and maintainability which this type of operation raises, one should also re-evaluate whether or not a "full mission simulator" should be used for several hours to induce crew fatigue and measure human errors throughout cruising flight in preparation for the more critical terminal area operations. A simpler part-task mock-up of the flight deck might well suffice as a surrogate for accelerating fatigue, if it provided appropriately higher temperatures, relative humidity, sound, and vibration levels together with the necessary control-display equipment primarily for CNI and systems management tasks during cruise. Such a surrogate environment for inducing crew fatigue could serve directly to make the more complete "specific mission simulator" more productive for terminal area research and less vulnerable to the issue of reliability. Some of the qualifications for full and specific mission simulation have been expressed before by others, particularly in the context of training simulation, as exemplified by the following quotation:

"I would not consider the money being spent on flight simulators as staggering if we knew much about their training value, which we do not. We build flight simulators as realistic as possible, which is consistent with the identical elements theory of transfer of Thorndike, but the approach is also a cover-up for our ignorance about transfer because in our doubts we have made costly devices as realistic as we can in the hopes of gaining as much transfer as we can. In these affluent times, the users have been willing to pay the price, but the result has been an avoidance of the more challenging questions of how the transfer might be accomplished in other ways, or whether all that complexity is really necessary." (Ref. 50)

In contradistinction, the "synthetic task simulation" in Table 9 enables the investigator to design low variability highly sensitive tasks which provide not only basic behavioral factors but may also provide workload measurements. Thus the experimental design tends to be more efficient and usually leads to reasonable fiducial statistics for specific tasks. There is a cost for this, however, among the "con" factors in the

"synthetic task simulation" column in Table 9. The synthetic task simulation may have lower face validity for specific mission simulation and a possibly low motivational value among the population of subjects for the tests. As a consequence, "part-task simulation" (middle column in Table 9) is the most prevalent compromise for the purposes of research and development, although the "specific mission simulation" continues to prevail for the purpose of flight and ground control training in spite of the dearth of objective data justifying its necessity.

Very complex mathematical models do not necessarily guarantee high simulation fidelity or validity. Complexity can just as well impede the effective use of simulators and can foster a false sense of well being. Let us explain.

Simulator models are frequently developed using actual wind tunnel data, detailed flight control system diagrams, replication of aircraft cockpit layouts, and anything else which may be regarded as the last word in definition of the actual aircraft, as noted previously. While there may be an undeniable correctness in such descriptive information, it may lead to such complex model definition that thorough checkout is impossible within a reasonable period. Furthermore there might be no perceptible difference in the induced pilot behavior over a less complex model.

The other side of the complexity coin is that simple models are suspect — their credibility is open to question. And demonstration of their value or fidelity may be just too costly. It is important to search out the middle ground, however.

The level of complexity of simulation must be set such that two things are possible:

1. The model must permit effective verification and check-out — this favors simplicity.
2. The model must enjoy credibility — this often (but not always) favors complexity if the background information for justification is itself complicated to express.

C. CRITERIA FOR FIDELITY OF THE SIMULATED IFR COCKPIT,
EXTERNAL VISUAL FIELD, AND MOTION AND AURAL CUES

Our approach to this problem is unique and may be described as follows. If the compromised visual, aural, and motion cues are such as to elicit the correct (real world) pilot behavior (but not necessarily identical system error performance) in the simulator, then a positive benefit is obtained from the simulation and negative transfer will be minimized. By pilot "behavior" we mean the nature and timing of his control actions, and the use of corresponding input cues.

Although a pilot's actions are varied, we must focus our attention among those actions which exert control on the aircraft, if we are to address the critical issues affecting the role of simulation in the MVSRRF. By so limiting the conceptual context, we also help to convert an unmanageably complicated general problem to a manageable complicated set of specific problems.

The conceptual context for defining and measuring pilot behavior derives from the following observations:

- The pilot involves himself in guidance and control loops which relate perceived elements of the visual field to his vehicle control actions in a coherent (and even predictable) way.
- The pilot optimizes the dynamic properties of the control loops by suitable behavioral adaptation.
- There is a cost to the pilot for this adaptation: in workload-induced strain, in concentration of his faculties, and in a reduced potential for coping with the unexpected.
- Motion cues may provide an alerting and triggering stimulus which activates an internal command generator within the pilot. This is perhaps most important for unusual recovery maneuvers.
- Motion cues indicative of status, such as moderate vibration, buffeting, stick-shaking, or moderate steady acceleration also provide an alerting stimulus and a consequent increase in neuromuscular tension. This reduces the effective neuromuscular time delay, thereby

permitting the pilot to operate with a higher gain, which may improve flying precision. Higher steady and vibratory accelerations, however, will ultimately degrade the pilot's gain and be counterproductive.

- Motion cues which conflict with the visual modality can cause illusions which distort the pilot's perception of the situation. If such conflicting motion cues are not disregarded, they can severely degrade the pilot's control capability.
- Vehicle motions sensed by the pilot which do not conflict with the visual modality are used as the basis for closed-loop control.

These observations are developed more completely as fundamental concepts for characterizing human pilot behavior in Ref. 14. In what follows we shall consider each of several classes of simulated cues in turn.

1. Head-Down Cockpit Displays, Controls, and Procedures

The representations of head-down cockpit displays and control "feel" characteristics in flight simulators have achieved such a high degree of identity with their prototypes that, with a modest capital investment, fidelity can be assured currently as long as careful attention is given to the mathematical modeling of the interacting vehicle and environmental dynamics. Partial task research simulators, however, usually lack realism in the normal cockpit procedures which are essential features of flight training simulators. Sometimes omitted are checklists, air-to-ground communications, copilot altitude and airspeed callouts, and activities such as selecting and interpreting radio navigational aids and making configuration changes. Although deliberate omission of such discrete tasks is perhaps expedient in partial task simulation, it does help to destroy the illusion of flight and, more crucially, may eliminate workload which is important to an evaluation of the impact of unexpected events in the MVS RF.

2. Visual Cues (Including Head-Up Displays)

The representation of the various and sometimes complex elements of the external visual scene (including collimated head-up displays) must be adequate to evoke (and allow) pilot control behavior typical of that in the real world. This does not necessarily mean a high fidelity representation in the photographic sense. It is possible, however, to base the adequacy of image quality and movement performance in the representation of the external visual scene on known limitations of the human visual system for the specific flying task in question (Ref. 11). It is also possible to base the adequacy of the image presentation technique (i.e., real or virtual) on a psychological measure of realism (Ref. 44) which is related to the pilot's perception of the external world in flight (Ref. 47).

It is also possible to base the adequacy of content and field of view in the representation of the external visual scene on the (predictable) characteristics of the pilot-vehicle system for the specific flying task in question (Refs. 18 and 51). For example, the simulator visual scene must provide adequate cues for attitude (pitch and roll) and heading references. Close to the ground, lateral and vertical position references are needed for landing, be they provided by representations of the ground plane, buildings, patterns of lights, visual landing aids, or whatever. Further, the capability of degrading the visibility of these references (e.g., by obscuration or reduced contrast) would also appear necessary for adequate representation of transitions from instrument meteorological conditions (IMC) to visual meteorological conditions (VMC) during the landing approach. The result of these considerations is that the fidelity objectives for the visual scene become task-dependent when related to pilot control behavior for a particular class of vehicles.

3. Motion Cues

The subject of motion cue simulation is about as complex as the one of visual cues. The basic problem is that, except in special circumstances,

it is impossible to simulate the physiologically perceived motions on a one-to-one basis. The angular motions could be provided relatively inexpensively, but large translational displacements would also be required, and these are extremely expensive. The most difficult situations for getting realistic motion cues are maneuvers which involve sustained normal accelerations, such as turns, pull-ups, and flares. Sustained lateral and longitudinal specific forces, at least of low magnitude, can be simulated by what is commonly referred to as residual tilt. This involves tilting the simulator cab relative to the vertical and using gravity to provide the sustained specific force components without having to accelerate the cab. For example, the acceleration during a takeoff can be simulated quite well by simply tilting the simulator cab backward and the deceleration during an approach, by tilting the cab forward (Ref. 45).

Given that motion cues cannot really be duplicated on a one-to-one basis, the usual procedure is to provide compromised motions within the physical constraints of a particular simulator. This usually involves a combination of three techniques: scaling the motion down, washing it out, and using residual tilt. Scaling the motions by some factor directly reduces the travel requirements. Washout circuits allow duplication of high-frequency components of the motions without a large amount of travel. The rationale behind the use of washouts is that the pilots use motion cues primarily as high-frequency adjuncts to the visual cues. The pilot may sense the roll motion from a gust before he sees the effects on his instruments or in the visual scene. Conversely, pilots are taught to ignore low-frequency motion sensations because they are unreliable.

The obvious question is: why simulate the motion at all, if compromises are necessary? Why not just have a fixed-base simulator? For one thing, the motion certainly contributes a psychological sense of realism for the pilot subjects. Even more important, motion cues can be very helpful to the pilot in certain situations. Motion cues can help in the pilot's responses to an engine failure or a hardover control system failure. They can also help the pilot's ability to control a difficult set of dynamics when the external visual field is also available (Ref. 52). It is generally recognized that motion cues are usually more

important when trying to evaluate the controllability of more difficult aircraft dynamics, such as those associated with a backup flight control system.

The pilot's perceived motion cues are a source of information which can be used as a control feedback. The pilot feedback selection hypothesis (Ref. 14) states that the pilot will use whatever feedback signals are available and helpful to him in accomplishing his task. Such feedbacks may be among visual, motion, or aural types. In the simulator, pilots may be deprived of helpful cues which exist in the real world, but they may also learn to use helpful but unrealistic cues which are artifacts in the simulator (Ref. 53). Thus one must be cautious about providing only angular motion cues in the simulator (which are potentially useful to the pilot), but which are not present in the real world without corresponding specific forces which accompany translation.

Recently Systems Technology, Inc., (STI) has been investigating (in a cooperative program with the 6750th Aerospace Medical Research Laboratories at Wright-Patterson Air Force Base) the role of motion cues in piloting tasks. A careful set of experiments on the WPAFB Dynamic Environment Simulator (DES) and Large Amplitude Multi-Mode Research Simulator (LAMARS) are under way. Data from these experiments are showing that, as predicted by the validated pilot-vehicle theory (Refs. 52, 53, and 54) motion cues are useful for disturbance regulation but are less useful for visual target tracking (Ref. 55).

4. Aural Cues

Aural cues in flight come from several sources including: noise generated by air flowing over the aircraft, rotor, propeller or fan noise, engine noise, landing gear and flap actuation sounds, and runway rumble. Except for rotor and engine sounds, aural cues seldom provide important feedbacks to the pilot.

The pilot can confirm power changes based on the sounds without having to monitor continuously his rotor and engine instruments. In situations where frequent modulation of power is part of the task, simulation of the

rotor and engine sounds can be quite important. It is therefore essential to have the proper dynamics or lags between the pilot's movement of the power or thrust controls and the accompanying engine sounds.

In many simulators the rotor-and-engine noise is simulated, not so much as a useful cue to the pilot, but to mask the noises made by the motion system. The noises made by the motion system may be useful but unrealistic feedbacks and, at best, are a source of distraction and annoyance to the pilot.

5. Element of Surprise

One of the most difficult types of experiments to do in a simulator, or in flight, is to study engine, aircraft, or flight control systems failures or wind shear encounters. The basic problem is the lack of the element of surprise. When the pilot expects a wind shear or knows he is going to get a failure on a particular run, his response certainly is not going to be typical of what happens in the real world when the failure is unexpected. If an entire experiment is devoted to studying wind shear or failure conditions, it is difficult to get this element of surprise other than, perhaps, the first time. If, on the other hand, the experiment includes other objectives, some element of surprise is possible. The idea is to mix the wind shear or failure experiments with other more routine parts of the test, so the subjects never know exactly when they might get a wind shear or failure. The results are still not completely realistic, but at least it is a step in the right direction.

6. Summary

This approach to assessing the value of a simulated situation has served well in a number of investigations, ranging from the study of (a) various forms of beam stabilization logic for the Fresnel Lens Optical System (FLOLS) (Ref. 56) through (b) the investigation of a large number of aircraft handling qualities problems on fixed-based simulators to (c) the refinement and effective operation of a number of FAA and NASA STOL

aircraft moving-base simulations at the NASA Ames Research Center's Flight Simulator for Advanced Aircraft (FSAA) (Refs. 57 through 60).

To summarize, we base our approach to determining the adequacy (i.e., fidelity) of the simulated visual field and motion cues on a well validated combination of pilot-vehicle theory and experiment which shows that the elicitation of correct decision-making and control behavior, measured by sophisticated control-theoretic techniques (such as pilot describing functions and structured parameter identification), is the best criterion for fidelity. It is this important concept, which is substantiated in Ref. 2, which we recommend to identify the critical issues affecting the incidence of human error in the MVSRF.

SECTION III

VISUAL FIELD

For limited or fully interactive piloted control in landing, the visual field display is essential as the primary means for monitoring and effecting attitude and path control of the aircraft. Here realistic visual scene cues are required so that familiar piloting reflexes can be employed.

Functional requirements for the visual field display fall in the categories of field of view, resolution, color, interactive image generation, image presentation optics, and update rate.

A. FIELD OF VIEW

At first thought, one would think that the largest display (in terms of lateral visual arc) would be desirable, since many of our motion cues appear to come from "streamer" motion in the peripheral areas (30 deg to 70 deg off axis), Ref. 24 - 26. Certainly such wide fields are more realistic and are needed for airborne traffic detection, ground roll-out, taxi and docking. On the other hand, we have noticed that the larger the visual field (in terms of percent of retina covered), the greater is the sensitivity to missing physical motion cues. It has been well established by Graybeil and his colleagues (e.g., Ref. 61) that "vertigo," "disorientation," and motion sickness stem primarily from conflict between the perceived visual and physical motion cues. If strong motion cues are supplied visually (especially parafoveally) but not physically, a vertigo effect results. This can increase with time of exposure from vague stomach "awareness" to acute malaise, or frank sickness. Nearly everyone is familiar with this effect while watching a 160 deg Cinerama picture taken from a rollercoaster, airplane, or fire truck (thousands of viewers at Disneyland's 360 deg Circle-Vision show have queasily experienced the latter). Yet the same scene compressed to a small area (as on a TV-replay of the same Cinerama movie) does not induce vertigo, because the visual

surround is not moving. Thus there is a paradox to be resolved: a wide view enhances realism of the situation but causes distraction in the form of vertigo.

A crude estimation of the compromise visual field size can be made from a rough plot of anecdotal experience, as shown in Fig. 5. Further research should be done to quantify more precisely the apparent correlation shown. For present purposes, if the probability of vertigo is to be "occasionally," we conclude that a display having aspect ratio: width:height = 2:1 should subtend not more than 20 to 25 percent of the visual field to avoid short term vertigo. This implies a visual display subtending at the viewer about (40 deg to 80 deg) wide by (20 deg to 40 deg) high.

A wide field of view is important for the MVSRF because a number of the visual cues come from angles of 15 or 20 deg from the line of sight (e.g., the so-called "streamer" effects are predominant in the regions from 20 to 40 deg from the instantaneous vehicle velocity vector, see Refs. 23, 25, and 26). In our opinion, after performing simulated landings on both the Ames Research Center S05 Flight Simulator (which has a ± 15 deg field of view) and the SAAB Draken simulator (which has a ± 30 deg field of view), that the SAAB system is much more "realistic" and easy to use in a visual flight rules (VFR) manner than the Ames Research Center system, primarily because of a wider field of view. Unfortunately, an adequate research basis on which to select the desirable field of view for the visual representation is not yet available.

B. RESOLUTION

A "high acuity" projected image is the next most important visual field representation requirement. This is a complex combination of good imaging resolution capability (measured by visual angle limits) and high brightness contrast ratio. The ideal resolution would be equivalent to about 1 arc-minute at the eye, and 3 arc-minutes is generally considered good (e.g., Ref. 37). For a cathode ray tube (CRT) raster display over a ± 25 deg field of view this requires a 1000 to 2000 line display. These

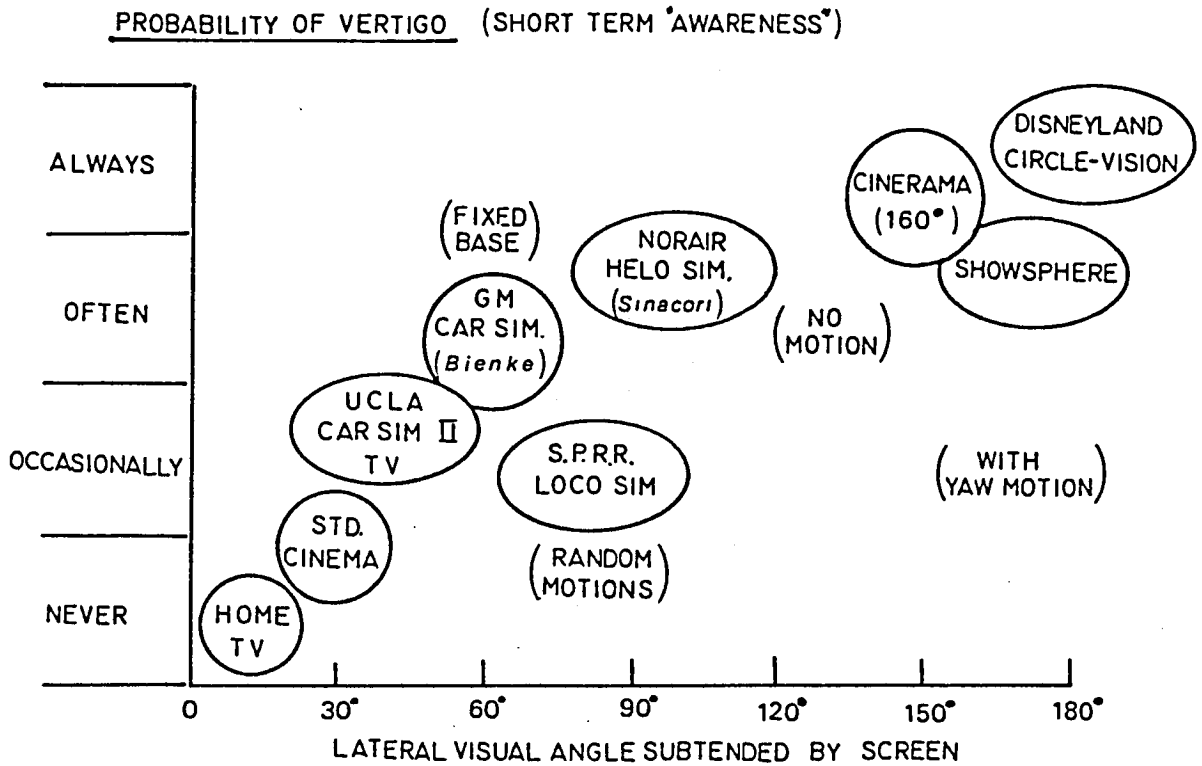

Figure 5. Anecdotal Experience with Vertigo versus Screen/Size When Viewing Dynamic Scenes from a Fixed-Base Situation (Ref. 62)

requirements are at the edge of the current state-of-the-art in CRTs. The CRT is further limited by a brightness contrast ratio on the order of 100:1 (as compared with cinematographic contrasts of around 1000:1). However large, monochrome, monitor-quality television displays of 1000+ line capability are now becoming available and are certainly worth considering.

C. COLOR

The need for color in the simulated visual scene is much more controversial than that for high resolution, probably because of the present difficulty in providing both. At a less-than-desired resolution level, some preliminary data on the desirability of color (and of a collimated CRT monitor versus a large nearby screen) is available from experiments reported in Refs. 63 through 66. Figure 6 shows the consensus of several transport pilots after performing hundreds of landings in the S05 Flight Simulator at Ames Research Center, using each of four display presentations: monochrome on screen, color on screen, monochrome collimated CRT monitor in window, and color collimated CRT monitor, all with a 625 line raster with roughly comparable fields of view (± 15 deg). The color monitor was considered best, monochrome monitor next, the projector in color next, and the monochrome projector the least. In certain situations (e.g., clear day VFR flight and low speed flight) the color was considered to add considerably to the optical contrast and to permit easier identification of significant land features. Under low visibility conditions, where color contrast is reduced anyway, the monochrome systems were not considered much worse than the color systems.

In the landing approach, the pilot's range and height perception, tracking precision on glide path, and decision to land or to go-around may well be influenced by the representation of color. Reference 67 points out that color provides an essential dimension for contrast cues, e.g., the blue scattering of the clear atmosphere with increasing range, the yellow scattering of the aerosol with range and height in urban areas, the absorption of color by water vapor with increasing range, and the gradual

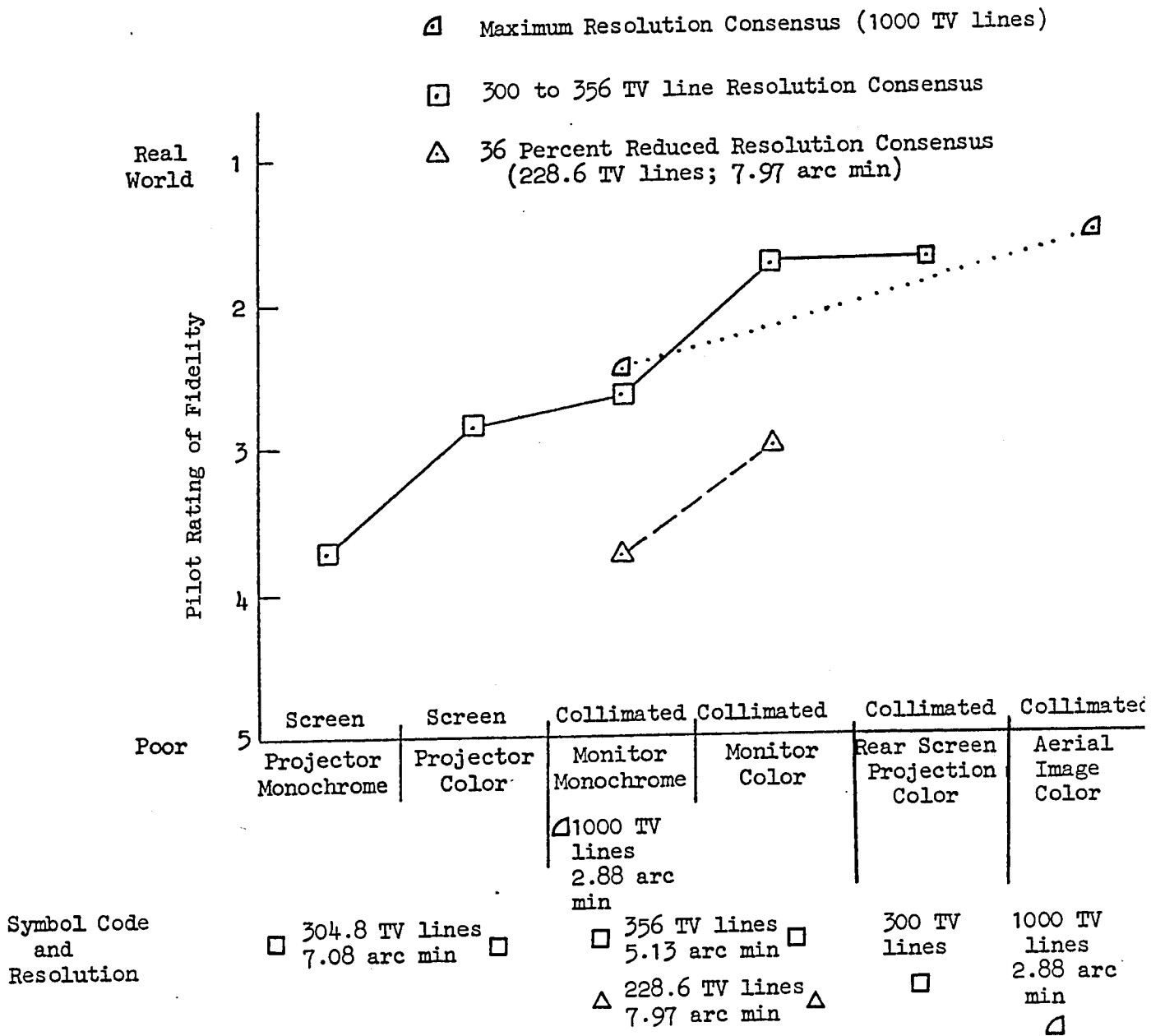

Figure 6. Pilot Opinion for Simulator Displays Compared to Real World Fidelity (Refs. 63-66)

loss of color perception as the light level reduces the effectiveness of photopic vision.

Under simulated night landing conditions the effects of chromostereopsis have been examined by comparing red approach and blue taxiway lights with blue approach and red taxiway lights in Ref. 66. Significant differences in altitude error and time away from glide path were found. With equidistant lights, red lights always appear to be nearer than blue. Red lights conventionally placed under the approach path as warning indicators of the runway threshold produce an illusion to the pilot that the aircraft is closer to the threshold than it actually is.

An additional factor, which may be significant in the precision landing control task at night, is the human response time delay to changing patterns in color. For foveal vision blue provides about 18 percent shorter response time delay than red (Ref. 67). With a nominal delay of 300 msec, such a difference is comparable with a typical digital computation delay in a visual simulator.

D. INTERACTIVE IMAGE GENERATION (FROM REF. 68)

Interactive image generation is essential for piloted landing simulation under VFR. "Interactive" means that the image of the visual scene is correctly influenced by the aircraft's translational and rotational motions induced by control inputs and disturbances.

At the present time CRT stroke writing (calligraphy) is probably the simplest medium for providing an interactive visual display of both the real world and electronically superimposed head-up display symbology. Cathode ray line graphics can be generated rapidly with electronic circuits (including hybrid computers), and intensity control can be used to obtain the desired range of image brightness. Graphic complexity and brightness are acceptable for generating night visual scenes. A large number of electronic computations can be arranged to operate in parallel so that image update rates can be maintained compatible with frame rates required to produce displays with excellent dynamic characteristics. This is not necessarily the case with digital computer-generated imagery,

however, which is limited by the serial processing characteristic of digital machines and where dynamic capability tends to be inversely proportional to image complexity. Table 10 presents some advantages, disadvantages, and typical examples of the use of each of these electronic approaches for generating interactive visual fields. We shall now discuss each technique in more detail.

1. Night Visual Graphics

A night-only visual system is recommended in the first phase of development for MVSRF. A relatively low-cost approach to night visual field representation can be provided by several computer graphics systems currently available as summarized in the first three columns of Table 11 which has been prepared with the aid of Refs. 69 through 73. (The fourth and fifth columns of Table 11 will also be used subsequently to represent examples of a display graphics generator for reproducing primary head-down displays in the flight deck.) These monochrome systems allow the control of a large number of points and vectors at update rates sufficient to present a subjectively smooth, continuous scene to the pilot together with electronically superimposed head-up display symbology. Visual perception of landing scene cues seems to be adequate with these systems (Refs. 74 and 75). The advantages of this approach are reasonable cost, programmability, and a common digital interface between the graphics system's dedicated computer and the "host" computer. The disadvantage of this approach is the absence of color. More expensive chromatic computer-generated approaches are possible, as discussed later, but the Evans and Sutherland Picture System 2 in Table 11 and the Evans and Sutherland Multi-Picture System, described in Table 12, offer growth capability for a high resolution red-green-blue (RGB) shadow mask color display at higher cost than monochrome Picture System 2 but at lower cost than computer-generated image (CGI) systems.

Meanwhile, Refs. 65 and 66 describe activities by Wendell Chase, a scientist at Ames Research Center, in pursuit of a relatively lower-cost (circa \$100K) full-color computer-generated visual field simulator

TABLE 10

ELECTRONIC APPROACHES FOR GENERATING INTERACTIVE VISUAL FIELDS

TYPE	TYPICAL EXAMPLES OF USE		ADVANTAGES	DISADVANTAGES
	FLYING TASKS	NON-FLYING TASKS		
Electronically Generated Calligraphic Imagery (Parallel processing by special purpose or hybrid computer)	Virtual Image Takeoff and Landing (VITAL); Light Airborne Multi-Purpose System (LAMPS) AF Avionics System Analysis and Integration Lab; Digital Avionics Information System (DAIS) Naval Air Development Center - Advanced Integrated Display System (AIDS); Aerospace Medical Research Laboratories AF Human Resources Lab - Advanced Simulator for Undergraduate Pilot Training (ASUPT) AF Aerospace Medical Research Lab Langley Research Center Pacific Missile Test Center Airframe Development Industry Naval Training Equipment Center AF Aeronautical Systems Division	Systems Technology, Inc. MIT Man-Machine Lab. Calapan U.C. Berkeley SAAB Volkswagen	High repetition rates for dynamic displays Continuous intensity control No time penalties for computational complexity (parallel processing) Natural for dynamic, interactive display (high rates of motion) Sharp resolution of far field	Complex scenes impractical Basic contrast and brightness limitations of CRT's Difficult to render colored objects Not easily altered by reprogramming
Digital Computer Generated Imagery (Calligraphic or Raster)	U. Ill., Inst. of Aviation Research AF Flight Dynamics Lab Ames Research Center Johnson Space Flight Center Naval Air Development Center AF Human Resources Lab AF Aeronautical Systems Division Singer	General Electric U. North Carolina	Easily programmed (potential) Complex scenes with solid objects	Time penalties for increasing scene complexity (serial computation processing) Intensity gradations difficult Quantization of far fields

TABLE 11

COMPARISON OF GRAPHIC SYSTEMS

Nomenclature:	Picture System 2	Graphics 7	Series 3400 Interactive Graphics Display	Graphic Display System GCT-3000	Series 9000 Graphic Display System
Vendor:	Evans and Sutherland	Sanders Associates, Inc.	Vector General	Genisco Computers	Ramtek Corporation
Home Office:	Salt Lake City, Utah	Nashua, New Hampshire	Woodland Hills, California	Irvine, California	Santa Clara, California
Price Range:	\$70K up Monochrome \$20K extra for color*	\$35K up Monochrome \$1 to 3K extra for GSS-4 FORTRAN Graphics Support Software	\$45K up Monochrome FORTRAN Graphics Support Software	\$40K up Monochrome or color with cursor control option via joystick	\$60K up Modular Monochrome or color with cursor control option via joystick and process control keyboard option
Type of Display:	Calligraphic only Microprogrammable Character and Line Generators Independent intensity and contrast control	Calligraphic only Microprogrammable Character and Line Generators Brightness, contrast, focus controls	Calligraphic only Microprogrammable Character and Line Generators Intensity Control	Raster scan only Microprogrammable Conrac high resolution colored dot matrix tube	Raster scan only Microprogrammable Mitsubishi colored dot matrix CRT has 2K resolution of Conrac and is available in 15-in diagonal
Maximum Number of Displays/Controller:	6	4	4	Unlimited	4 to 12
X · Y · Z Addressable Locations/Display:	4096 · 4096 · 64	2048 · 2048 · 8	4096 · 4096 · 4096	1024 · 1024 · 4096	From 320 · 240 · 256 To 640 · 512 · 4096
Line Stroke Set	6 with adjustable blinking	4 with adjustable blinking	6 textures with adjustable blinking	(Bit map type refresh expandable from 1 to 16 bits/picture element)	(Bit map type refresh expandable from 1 to 12 bits/picture element)
Alphanumeric Character Type: Set: Size:	Cursive stroke 95 ASCII 8 std	Cursive stroke 96 std, 96 optional ASCII 4	Cursive stroke 96 ASCII std, 192 optional 4	Automatic video control	Automatic video control
Refresh Controller:	Automatic	Microprogrammable (40 instructions)	Programmable (6 instructions)	Automatic video control	Automatic video control
Refresh Rate:	Selectable among first 16 integral multiples of 1/120th sec	60, 40, or 30 Hz; or free-running	60 or 30 Hz	60 or 30 frames/sec	60 or 30 Hz
Display Processor	Microprogrammable	Microprogrammable (400+ instructions)	Microprogrammable (47 instructions)	Microprogrammable (51 instructions) with 150 nsec cycle time	Microprogrammable (26 instructions) with 350 nsec cycle time
Modular Memory	16K 16-bit words expandable in 16K increments to 64K words	ROM 4K 16-bit words RAM 8K to 24K words	32K 16-bit word refresh buffer 4K 24-bit word control program 247-word ROM constant file 248-word RAM data file	256 16-bit words RAM 1024 16-bit words RAM 1024 16-bit words RAM	4K 12-bit word refresh RAM 2K bytes program ROM expandable to 16K bytes 512 bytes scratchpad RAM expandable to 8.7K bytes (2 bytes-one 16-bit word)
Host Computer Interface and Software:	Parallel 16-bit word Synchronous at 6-2/3 M words/sec Designed for DEC PDP-11, but can be used with others at extra cost. Uses FORTRAN calls.	Serial RS-232C, 9600 baud std. or parallel 16-bit word Synchronous at 0.5 M words/sec Designed for DEC PDP-11, but can be used with others. GSS-4 resides in 2K word memory of host.	Designed for DEC PDP-11/45 with RX-11D operating system, which uses 32K word memory. Need at least another 32K word memory.	Designed for NOVA computer, but PDP-11 acceptable. No high- level software available. Would need software support. RAND Corp. uses Bell operating system. Periodic diagnostic maintenance contract @ 1% of purchase price per month.	8 different computer interfaces have been developed, incl. DEC PDP-11 series, Varian 620 and 73 series. Some high-level software available, but would need software support.
Reliability/Maintainability	Periodic diagnostic maintenance contract @ 0.75% of purchase price per month plus \$50/ display or \$650, whichever is greater. Demand maintenance service @ \$39/hr plus parts and travel expenses. Minimum 8 hr/visit.				High temperature burn-in of each system is used to isolate and replace premature component failures. No special preventive maintenance required. Demand maintenance contract @ 4% of purchase price per year provides 48 hour response. Technician at East Coast office as of April 1977.

* Red-green-blue (RGB) shadow mask monitor provides lower intensity than monochrome.

TABLE 12

EVANS AND SUTHERLAND MULTI-PICTURE SYSTEM (MPS)

(Adapted from Ref. 76)

The MPS offers several advantages and some disadvantages. The advantages are summarized below in two categories. The first assumes the use of a minimum system — one monochrome station. The second category of advantages covers potential growth capability available through MPS options. The disadvantages are presented last.

Advantages, Initial

1. Ability to generate runway symbols and lettering. The MPS can draw any symbol on the runway and display it with the proper perspective.
2. Greater flexibility. With the MPS it is possible to trade off scene complexity and update rate. One experiment might use a very fast update rate with a simple display. Another may not require the fast update and could use a much more complex visual scene. These can also be tradeoffs between complexity in the runway delineation and in the other display elements (such as other aircraft).
3. Alphanumeric capability. The MPS can draw alphanumeric characters as well as straight lines. This capability could be used to generate traffic situation displays.
4. Maintenance. The MPS is a standard off-the-shelf component and a maintenance contract is available from the manufacturer.

Advantages, Growth Capabilities

1. Color. The MPS has built-in color control capability and requires only the addition of a color display (price \$50,000). The color display is a high resolution, shadow-mask monitor. The drawing speed is the same as the monochrome monitor and is several times faster than beam-penetration monitors.
2. Increased field of view. One MPS can generate multiple views of the same data base (with a corresponding reduction in the maximum number of lines or update rate). With another kinescope this capability could be used to double the forward field of view or to add side or rear displays.

TABLE 12 (Concluded)

3. Controller's eye view. The multiple view capability noted above could be used to generate a special display for the controller or experimenter so he could more readily monitor the progress of the simulation. A controller's eye view of the simulated terrain with a moving symbol for the subject's aircraft would be possible.
4. Interactive graphics for scenario generation. A common application of the MPS is for interactive graphical design systems. A variety of I/O devices for these types of applications are available from Evans and Sutherland: data tablet, light pen, keyboard, joystick, dials, switches, and lights. With some of these devices and the support software which is included, an interactive graphical experimenter's station could be developed. This station would provide a sophisticated man/computer interface for the generation and modification of test scenarios.

Disadvantages

1. Higher cost. The MPS would definitely cost more than Picture System II.
2. Only draws straight lines or data. The MPS will use a number of lines to draw a dashed line or approximate a curve.
3. Does not draw wide line. The MPS only draws thin, straight lines. Multiple parallel lines could be used to approximate a wide line (or to fill in a solid symbol). The number of lines and spacing required would probably have to be determined experimentally.
4. Fixed intensity variation with range. The MPS can vary line intensity with range from the viewer; furthermore, the ranges for maximum and minimum intensity can be controlled by the host computer. What the computer cannot do is change the shape of the intensity variation with range, for example, to match that in fog. The shape of the intensity variation with range can, however, be altered by hardware changes at extra cost.

designed specifically for landing, which may have possible future application to MVSRF.

This new device, which includes a synchronized field-sequential colored filter wheel, has provided a full-chromatic spectrum for improving the perceived realism of night visual calligraphic generators. This new chromatic projector permits drawing 2000 vectors in as many as 500 colors, all above critical fusion frequencies and using high scene resolution and brightness at levels acceptable to the pilot within the maximum capabilities of 1000 (scan) lines and 100 fL. System and pilot performance measures and pilot opinion (Fig. 6) obtained in experimental investigations support the hypothesis that using a chromatic visual field simulator for landing improves both pilot and system performance.

The components of Chase's computer-generated display system are: (a) a Systems Engineering Laboratories SEL 840 digital computer, (b) an Evans and Sutherland Line Drawing System LDS-2, (c) a field sequential color projector and its rear projection screen, and (d) the supporting optical collimating lens arrangement for viewing the image of the visual field. The display can be presented on a five-inch diameter 40,000 volt monochrome CRT. Interposed between the f/1.0 projection lens and the CRT is a 24-inch diameter color wheel comprised of four sectors (red, green, blue, and clear). The rear projection screen is placed at the focal plane of the projection lens. Three photo diodes located on the rotating color wheel are used to synchronize the stroke-writing periods for the field sequential process. Two 25-inch diameter collimating lenses provide the pilot with a virtual image from the real image presented on the rear projection screen. The virtual image can be positioned ahead of the pilot from 10 ft to infinity. Interposing the rear projection screen causes some loss in resolution. One of the advantages of the rear projection scheme, however, is that it can be viewed off-axis with an acceptable level of distortion, thus allowing the pilot a range of lateral and vertical head movement within a diameter equal to the size of the real image on the rear projection screen.

2. Computer-Generated Image (CGI) Display System

The computer-generated image scheme is at the frontier of the state of the art. Table 13 provides a concise comparison of some of the salient features of six systems for generating visual field images in color. These systems are designed specifically for pilot training. To generate even relatively simple images with appropriate perspective and update rates compatible with real-time operation (at least in the 30 to 40 Hz update frequency range) requires a relatively powerful dedicated digital computer. The image can be created via either calligraphy or modulated TV raster. In either case, the pilot flies in a cartoon world of extreme visual simplicity, which may be limited to night-time scenarios, because of the higher cost of daytime CGI. It offers the greatest future potential for research because of its inherent flexibility, but the hardware and software requirements and costs are substantial.

Since the advent of the original General Electric (GE) CGI in the early sixties, significant studies have been made by several companies in achieving increased capability and scene complexity. The Evans and Sutherland Day/Night CGI, GE CGI, and Marconi TEPIGEN are the only true full color systems which are presented in a standard video raster. The other three systems, which are calligraphic and more modestly priced, are presented on beam penetration color CRTs which lack a blue phosphor. Personal observation has shown the colors to be subjectively quite appealing, however.

As noted in Table 13, available scene complexity is quite good and probably adequate for idealized landing scenarios. For example, the VITAL IV system with 250 polygons per scene and 25 possible automatically accessible scenes allows for over 6000 polygons. In developing a terrain data base we could assign, say, 2000 polygons to composing the general terrain contour, and use the other 4000 to generate stylized buildings and trees.

Advances in CGI techniques are currently proceeding rapidly. While the surfaces in the Table 13 systems are uniform planes, Marconi Radar Systems now offers a daytime CGI which can generate surface texture (Ref. 77).

TABLE 13

COMPUTER-GENERATED INFORMATION DISPLAYS FOR VISUAL FIELD GENERATION

	NIGHT		DAY			
Mononclature:	HDVOVIEW 6000	Vital III	EAS Day/Night CGI	Vital IV	TEPIGEN (Television Picture Generation)	COMPU-SCENE
Vendor:	Redifon	McDonnell Douglas Electronics Co.	Evans & Sutherland	McDonnell Douglas Electronics Co.	Marconi Radar Systems Ltd.	General Electric Company
Home Office:	Crawley, Sussex, UK and Arlington, Texas Manufactured by Evans & Sutherland, Salt Lake City, Utah	St. Charles, MO	Salt Lake City, Utah.	St. Charles, MO.	Chelmsford, UK	Ft. Lauderdale, Fla.
Price Range:	\$250-350K basic depending on optics, support, interface requirements, etc.	\$242K basic one display/channel \$550 - three channel	\$1.7 to 2 M	\$330K basic one display/channel \$60K per add. channel \$60K per add. display Custom interface/installation extra	£ 350K (\$700K)	\$1.5-2.5M
Type of Display:	Calligraphic, beam-penetration color CRT ¹ Virtual image optics optional	Calligraphic, beam-penetration color CRT ¹ Virtual image optics	Color raster scan, can display with monitor or projector	Calligraphic, beam-penetration color CRT ¹ Virtual image optics	Color raster scan, can display with monitor or projector	Raster scan, full color Both projected real images and virtual image optics
Brightness:	19 ft. L at display cut to 1/6 through beamsplitter	~3 ft. L	20 ft. L	~25 ft. L		~6 ft. L
Field of View:	37° vert. by 45° horiz. Basic one channel	30° vert. by 36° horiz. Options up to ~150° horiz		30° vert. by 36° horiz Options up to ~150° horiz	1 vert. by 120° horiz with 3 arc min resolution	Virtual image 32° vert. by 36° horiz. Projected 60° by 60°
Maximum Number of Channels/Controller:	2	3	3	3	3	
X * Y * Z Addressable Locations/Display:		4096 * 4096 * 7		4096 * 4096 * 7		
Scene Complexity:	6000 point lights plus 64 polygons basic (can expand to 256) Surfaces are monochrome Fog, SCUD, and cloud layers	600 point lights plus runway elements, fog, SCUD, and cloud layers.	2000 point lights, 400 polygons, 1600 vertices, convex and planar surfaces	600 point lights plus 250-300 four-sided polygons, fog, SCUD, cloud layers. 1/16 ft resolution	500 faces (approximately 1000 lines) to 5K faces	200-400 point lights 200-3000 edges (visible) Atmospheric effects 1 arc min., 8 inches resolution
Scene Generation, Control:	8 scenes stored on floppy disc Access unnoticeable	Similar to Vital IV	Several scenes per standard computer disc depending on complexity Automatically accessed	25 scenes stored on floppy disc < 1 sec access time, can be called up automatically	Pseudo-random numerical texture generation	
Refresh Rate:	30 Hz frame and update rate	30 Hz frame and update rate	25 Hz frame rate 30 Hz update rate	30 Hz frame and update rate	30 Hz frame and update rate	30 Hz update
Throughput Delay:	< 100 ms	33 ms	< 100 ms	33 ms		70 ms
Dedicated Computer Interface and Software:	TI 980B, 24K core Can increase to 64 K, multi	Varian 73 with dual processor 512 word writable control store and 3x16 K word dual port shared memory having 660 ns cycle time 25 parallel words for aircraft motion, 10 parallel words for scene element movement	DEC PDP 11/45	Varian 76 24 bit word, single processor can add additional processor and memory for special purpose computations		PDP 11/55
Reliability/Maintainability:						
Remarks:				Typical delivery, 9 mo.		

¹ channel means, a view from one orientation.

² beam-penetration CRT uses varying acceleration potential to obtain color, is relatively expensive, and ³ is simulated colors, except no blue.

E. IMAGE PRESENTATION OPTICS

The image, once generated, must be presented to the pilot via some combination of optics and screens; and this is the interface we are concerned with.

Two main alternatives for visual presentation follow.

1. CRT and Wide-Angle TV

A large, fixed-screen, front-projection system is arranged some distance in front of the cockpit (e.g., the Norair simulator). The projector is usually over or behind the cockpit. The projection screen may be predominantly in front of the cockpit for normal aircraft or STOL vehicle simulation, or it may extend downward more in the case of VTOL or helicopter aircraft. The viewing angle of the CRT image may be enhanced by projecting the CRT image on a wide screen using closed circuit projection TV. Figure 7 illustrates such a system using the Advent projection television system.

2. CRT and Collimating Lens

A "simulated window" is presented using a cockpit-mounted, collimated CRT monitor (or rear-projected television), e.g., as in the NASA Ames Research Center S05 Flight Simulator and Flight Simulator for Advanced Aircraft. More than one simulated window unit may be provided (e.g., one each for the pilot and copilot) or additional windows may be required for cases where parafoveal viewing is important. The CRT line graphics can yield an abstraction of the visual scene which provides an interactive "outside" visual reference sufficient for guidance and control tasks. Equipment requirements are modest, changes are easily made, and costs are low. The apparent realism can be enhanced using a collimating lens.

The real-world visual scene is tens to hundreds of feet in front of the pilot. Thus when he moves his head the scene does not change in azimuth. On the other hand, a rear-projection screen, if used instead of a

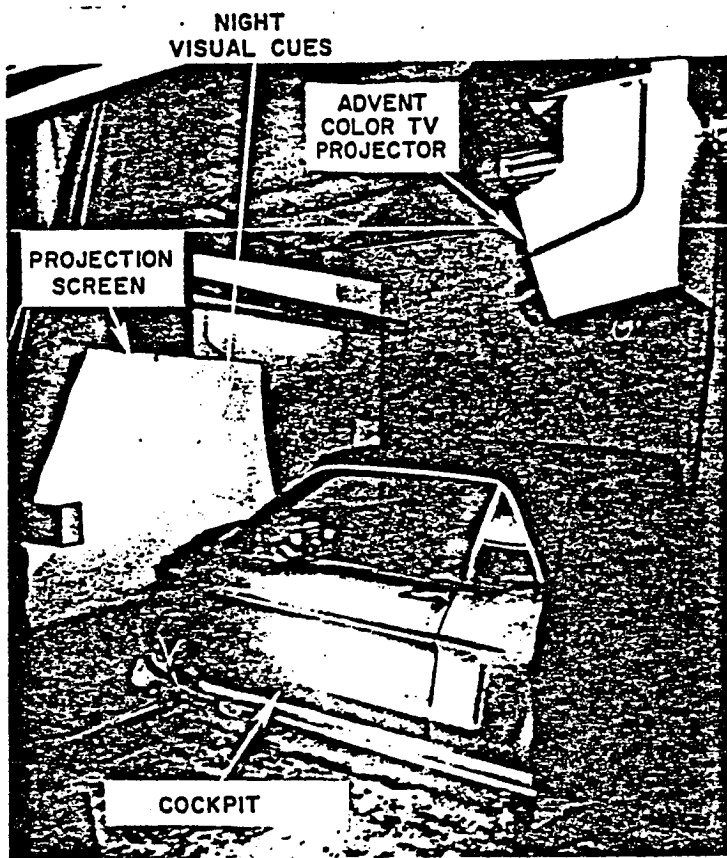

Figure 7. Example of Wide-Angle Projection TV System for Presenting a Visual Field Appropriate to Night Operations

directly-viewed CRT, needs to be kept close to the cockpit to minimize its size and space requirements. Thus a viewing distance of at least 8 to 10 ft is required for a plain screen with rear-projection. To provide a more distant focus and accommodation angle of the eyes, a faraway virtual image can be generated by a "collimating" lens placed near the pilot's eyes, or by a larger spherical mirror reflecting the source image. Subjectively, collimation does appear to enhance realism, but it raises problems of lenses in the cockpit, limited exit pupil, and how to handle the framing elements. These problems are not serious, however, in a fixed base application.

Table 14 lists some of the considerations favoring one or the other of these two basic schemes. The comments are based on several years of contact with various aircraft manufacturers, NASA installations, and visits to a few of the visual simulation installations in Europe (notably those at British Aircraft Corporation, Wharton, England; SAAB Aircraft Company, Linkoping, Sweden; and KTH, Stockholm, Sweden).

References 44 and 83 present results from an experiment which attempted to provide a direct measure of the psychological realism from a computer graphics night visual generator. The measure of realism is based on Gilinsky's research concerning the effect of instructions to the subject on the perception of size (Ref. 19). These and other results examined in Appendix A suggest that collimation contributes to the perceived realism of the generated visual scene when compared with direct viewing of a comparable scene on a CRT display.

References 63 and 64 also describe some of the tradeoffs concerning the choice between collimation or front screen projection for presenting a generated visual field on several TV display systems. From the objective landing approach and touchdown performance measures as well as their subjective confirmation by trained commercial pilot, Refs. 63 and 64 conclude that a collimated monitor appears to be more satisfactory than a front screen projector for the television display system tested. This conclusion is qualified, however, by a recommendation for more study on changing the degree of collimation on the monitor or on collimating the projector, and comparing results so obtained with those reported in

TABLE 14

CONSIDERATIONS FOR LARGE FIXED SCREEN VERSUS COCKPIT MOUNTED VISUAL FIELD SIMULATORS

LARGE FIXED SCREEN AND CRT PROJECTOR

- Limited to a single fixed installation, due to large screen and floor area required.
- Subjectively poor depth realism. (Refs. 19 and 44).
- Can cover large visual angles, (if linear motions are limited).
- Viewing distance of 10 to 20 ft requires parallax correction for long range objects
- If cockpit motion is required, projection must be synchronized to cockpit angular and linear motions, with smooth, high-bandpass fidelity. Therefore flat screen must be much larger than desired field.
- High-acuity large size CRT projection now achieved, especially with color. (Advent Projector)
- Easy to interpose various window occlusions, actual HUD devices, etc.
- Cost: ~ \$2,000 to \$5,000 plus motion compensation system, if required.

CAB-MOUNTED, COLLIMATED CRT MONITOR OR PROJECTOR

- Can be mounted on any cockpit unit; multiple units feasible.
- Subjectively more realistic depth cues. (Refs. 19 and 44).
- Limited visual angles, depending on aperture and viewing distance.
- Requires large collimating lens
- Perspective is inherently synchronized with cab motions. All of display field is utilized. Weight of display unit adds to moving cockpit inertia.
- High-resolution raster or dot TV monitors are now available (1,000+ lines feasible and practical). Satisfactory color CRT monitors are imminent.
- Wide angle simulations (± 30 deg visual angle) require collimating lens close to eye, which complicates simulation of framing and HUD devices. If lens-at-window is used to avoid this, larger lenses are required.
- Cost: ~ \$3,000.

Refs. 63 and 64. To the best of our knowledge, this further study and comparison has never been made at Ames Research Center.

Our experience with "plain" screens versus "collimated" presentations (which put the scene's virtual image at a far distance) indicates that collimation is an almost mandatory requirement for "realistic" visual presentations. Two types of collimation system have been used. Most American systems place the collimating lens in the windshield position, relatively far from the pilot's eyes, thereby limiting the field of view to the order of ± 15 to ± 20 deg. The European systems put the collimating lens very close to the pilot's eyes, thereby permitting visual fields of ± 30 to ± 40 deg. The former arrangement permits inserting various head-up display devices between the pilot's eyes and the collimation lens, while the latter system requires generation of such devices via either a half-silvered inclined mirror in the optical path between the collimation lens and the projector or by electronic superposition of symbols. Both schemes should be carefully considered in the light of other requirements before final selection is made.

Keeping in mind that the early MVSRF generation problems will concern conventional transport aircraft problems, that conservation of floor area is desirable, and considering that large, economical collimating lenses are now readily available — we believe that a cockpit-mounted "simulated window" visual display system with CRT and collimating lens is preferable. Predominant considerations for the facility are the versatility afforded by the small, lightweight units (which can be mounted in front of the pilot-copilot on any flight deck, as required), the ease of eventually using the visual display system in conjunction with a moving-base system, and the minimal physical space requirements of the simulated window concept.

F. UPDATE RATE

A usable interactive visual landing display must appear smoothly continuous, i.e., have no "strobing" (stopped or reversed travel of discrete scene elements which contribute visual "streamers") or "flicker," and it

must respond to pilot control inputs without any noticeable computational delay (i.e., with less than 0.04 sec delay).

Flicker (flashing of the drawn scene) is avoided by maintaining a display refresh rate well above the pilot's critical flicker fusion frequency. An effective refresh rate of 60 fields/sec was originally selected by the television industry to avoid flicker problems. Given this video refresh rate, we must then appropriately update the CRT portion of the raster scan converter to avoid strobing or interference between the CRT update rate and the video refresh rate. When the update rates are not synchronized, tests have shown that the CRT update rate must be on the order of 100 times/sec to avoid strobing effects with the 60 Hz video rate.

Given that one has achieved a flicker-free display, then the question arises as to how often the scene composition is updated. Motion picture experience would suggest that 24 frames/sec is a lower bound on update rate in order to achieve the appearance of smooth motion. However, high image motion will be recorded on film with some blur due to the nominal 1/50 sec shutter speed used in a typical movie camera, and the recorded blur helps to give the illusion of continuous motion. Computer-generated imagery does not have the softening effect of this blur characteristic, and thus requires somewhat higher scene update rates to appear continuous. Update rates of 30 scenes/sec are marginal, and 60 scenes per sec would be desirable to be consistent with the video refresh rate.

Computational delay, or the minimum time between a control action and subsequent display motion, is the final critical characteristic of display quality. As far as the pilot is concerned, delays in scene computations are interpreted as delayed vehicle response. Such computational delays in scene update are subjectively very annoying, and increase operator mental workload even when effects on performance (accuracy of control) are not readily apparent. Recent aircraft research (Ref. 78) has shown that delays on the order of 0.05 sec cause a degradation in pilot rating of vehicle response of one unit on a 10 point scale, which is a rather severe penalty for a simulation artifact.

In most CGI systems the scene update rate and computational delay go hand in hand, since the scene can be updated only when the computations are completed. This double effect makes computational delay a critical factor. Thus 0.04 sec for the combined computational delay of vehicle equations of motion and display scene content represents an upper bound. Exceedence of this upper bound can be expected to cause penalties in simulation fidelity and unrealistic psychomotor workload in precision landing tasks.

G. SUMMARY

In summary, our recommended visual field display system (from the pilot interface point of view) is a cockpit-mounted "simulated window," using a reasonably large collimating lens near the pilot's eyes. The exit-pupil should be at least 1 ft diameter, and the virtual image should appear further away than 40 ft. The image source should be a high quality (1000+ TV line, 21 inch) CRT. If the probability of vertigo is to be only "occasionally," an image source having aspect ratio (width:height) 2:1 should subtend not more than 80 deg wide by 40 deg high at the viewer for landing operations. The width of the field of view can be allowed to exceed 180 deg to encompass the entire windscreen for airborne traffic detection studies. As long as the 180 deg visual field remains impoverished, the probability of vertigo will remain only "occasionally."

The choice of visual field display for the MVSRF depends on many factors: program design objectives, equipment availability, reliability, maintenance requirements, software requirements, and cost. Considerations of reliability, maintenance, and cost certainly favor the relatively simple collimated CRT with a monochrome night visual graphics system, but subjective pilot ratings of realism favor the inclusion of color capability at modest increase in cost for night visual graphics.

SECTION IV
MOTION CUES

In establishing requirements for the simulation of cockpit motion, consideration must be given to the effects of motion cues on:

- Tracking
- Failure detection
- Discrete maneuvers
- Illusions and disorientation

Our discussion of each of these topics will be based on research reported in Refs. 52, 53, and 79.

A. TRACKING

With regard to tracking performance, it is generally more important to have the rotational cues than the translational ones. If tracking performance were the sole criterion, the translational motions might even be eliminated altogether as long as the task did not require a translational acceleration feedback which had no visual equivalent. Nevertheless one must be cautious about providing only angular motion cues in a simulator (which are potentially useful to the pilot), but which are not present in actual flight without corresponding specific forces which accompany translation.

However, as we will see shortly, there are other arguments for including translational motion besides their effects on pilot tracking. If the translational motion is provided, then from the tracking standpoint, we can establish a desirable frequency range to reproduce the motions. This range would be on the order of 0.5 to 5 rad/sec. The higher frequency cutoff for the translational motions is less than that for the angular motions because of the much lower bandwidth of the vestibular sensors, the utricles.

There is one other aspect of the translational motions which should be considered with regard to the tracking tasks. In certain rare situations, such as storm penetration, the translational motions can be severe enough to interfere with the pilot's tracking by either degrading his ability to see the visual display or by degrading his ability to manipulate the controls in the desired manner. In this situation the translational motions are affecting the tracking, not in that they are providing a cue, but in that they are interfering with the task.

On the other hand, the rotary motions should be faithfully reproduced, at least over an appropriate frequency range. A reasonable high frequency limit is 10 rad/sec. This is the bandwidth of the vestibular sensors, in this case, the semicircular canals, and is considerably above any manual-control crossover frequencies. For the low frequency limit, it does not appear necessary to go as low as the vestibular sensor washout, roughly 0.1 rad/sec. A conservative lower frequency limit would be 0.5 rad/sec and even 1 rad/sec would be reasonable.

Tracking requirements are also affected by controlled element dynamics. For an easy control task, one requiring little pilot lead equalization, the effects of motion cues are considerably less than for a difficult task, one requiring large pilot lead equalization. Fixed-base results may be completely adequate, although slightly conservative, for a vehicle with good handling qualities. On the other hand, fixed-base results for a vehicle with poor handling qualities or a marginally controllable task will be overly conservative.

The following procedure should be used to estimate motion simulation requirements for a specific tracking situation:

- Define the system — piloting task, vehicle dynamics, displays, inputs, and disturbances
- Determine potential visual and motion feedbacks for the task
- Analyze the flight situation using the Multimodality Pilot Model and, if necessary, the Multiloop Pilot Model (Ref. 14)

- Reanalyze with a variety of simulator dynamics included (e.g., Ref. 80)
- Determine limits of simulator dynamics for acceptable performance degradation relative to flight.

B. FAILURE DETECTION

The second consideration affecting motion simulation fidelity requirements is failure detection. If the piloting task includes recovery from an aircraft, rotorcraft, or system failure, such as an engine or stability augmentation failure, motion cues can play an especially important role as alerting cues. The motions accompanying a failure can help greatly in the pilot's timely detection of the failure. This is especially true if the visual modality is already heavily loaded with a demanding task. For example, a hardover elevator due to a pitch damper failure could be detected by the normal acceleration and pitch rate motion cues before noticeable effects were displayed on the flight instruments (such as the artificial horizon).

At present no general requirements based on failure detection are available. As a minimum, the motion should be enough to provide an unambiguous clue to the failure. For example, to simulate a hardover yaw damper malfunction, the simulator should have enough lateral travel so that the pilot can clearly separate the lateral acceleration cue accompanying the failure from those due to gusts. In many cases failure detection may put the most stringent requirements on translational motions.

In one experiment at NASA Ames Research Center, flight in gusty air was simulated and various amounts of lateral travel on the six-degree-of-freedom simulator were utilized. It was found that with very limited travel, the pilot could not differentiate between an engine-out and a side gust. In fact, with the very small travel, 4 inches, the pilot could not, in some cases, even determine the direction of the initial acceleration. The pilot just experienced a sharp side impulse, but was unable to determine the direction.

A technique for reducing the amount of linear travel required has been suggested. This technique is to scale down the linear accelerations from those which will be experienced in real life. Scaling down the accelerations by some factor would, of course, also scale down directly the linear travel requirements. Conceptually this sounds like a reasonable approach, but its validity has not been thoroughly established.

It should be clear by now that it is extremely difficult to establish accurately the linear travel requirements for the simulator. Given a specific situation, including a specific vehicle and flight condition, one could probably estimate with reasonable accuracy the requirements for that task. On the other hand, to cover the many combinations of missions and vehicles for which the simulator will be used, the best we can do is make some rough estimates. If we take a reasonable acceleration level, like 0.1 g, and assume that this acceleration must be maintained for the order of 1 to 2 sec, which is typically the sort of time required for the pilot to react to a failure, then we come up with travel requirements on the order of ± 5 to ± 10 ft.

Before leaving the subject of failure detection, we should also point out that while the linear cues are important in detecting the failure, the angular cues can be very significant in the subsequent recovery maneuver. This would be especially true for a failure of the stability augmentation system. Then the pilot would be faced, not only with a large transient input, but with a sudden degradation in vehicle dynamics. In this situation the angular motion cues would probably be of critical importance in simulating the recovery operation.

C. DISCRETE MANEUVERS

The third consideration affecting motion simulation requirements is providing realism during large discrete maneuvers. Examples of the sorts of maneuvers we are considering here are sustained turns, pull-ups, and translation from one spot to another in a hovering vehicle. For this class of maneuvers, accurate duplication of linear motion cues is impractical. Duplication of sustained linear accelerations in a ground-

based simulator becomes an extremely costly proposition. The cost involved cannot be justified on the basis of the added realism. A practical solution is to provide a limited amount of linear travel and to restrict the maneuvers which the pilots are allowed to perform on the simulator. With limited linear travel, the pilots could do short duration discrete maneuvers. On the other hand, they should be prevented from trying long duration maneuvers when the linear motion system is operating. The idea here is that no motion cues are better than the wrong cues.

Two specific problems which compromise the pilots' impressions of realism are false translational accelerations and washout effects on open-loop maneuvers. An example of the first would be roll control in a simulator with roll motion but no lateral travel. When the subject rolled the simulator he would sense a proportional lateral acceleration because of gravity, whereas in an airplane the perceived acceleration is generally very small (e.g., the turn is "coordinated"). Not only may the false cue affect the pilot's control behavior, but it will surely influence his subjective opinion of the simulation realism. An example of the washout problem would be a pull-up maneuver in a simulator with limited vertical travel. The initial acceleration would be correct but, because of the limited travel, it would be necessary to reverse the acceleration quickly. The reverse acceleration is in the opposite direction to that being commanded by the pilot and certainly could be confusing. Thus washout characteristics, which might be completely masked in a tracking task, could become quite obvious in certain open-loop maneuvers.

Another item should be mentioned in this regard, and that is the utilization of gravity to lower the linear travel requirements. By rotating the simulator and visual display at angular rates below the pilot's threshold, one can reorient the pilot and make use of gravity to provide the sensation of a sustained fore and aft or lateral acceleration. Figure 8 illustrates how this concept might be mechanized.

A series of moving-base flight simulator experiments has been recently performed using roll and sway motions of the Large Amplitude Multimode Aerospace Research Simulator (LAMARS) of the Flight Dynamics Laboratory at

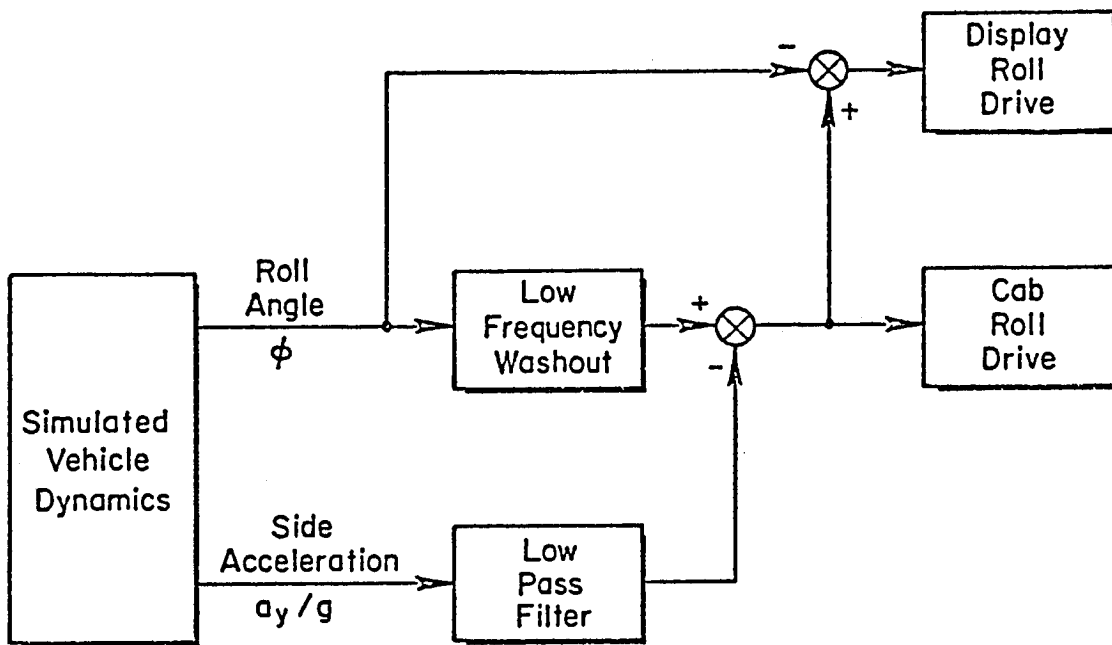

Figure 8. Low Frequency Corrections for Gravity

Wright-Patterson Air Force Base, Ohio (Ref. 79). The accompanying visual scene provided only the rolling degree of freedom for the pursued and pursuing aircraft with respect to an impoverished homogeneous background with no visible horizon. The objectives of these experiments were:

1. To tie in the roll-only visual-and-motion simulation results of the four experienced pilots with previous results (Ref. 81) for four well-trained nonpilot subjects.
2. To investigate effects of various lateral-beam-motion "washout" filters designed to keep the lateral sway within the ± 10 ft of LAMARS travel. (Lateral beam sway is used, within limits, to imitate the realistically "coordinated" lateral motions of free-flight roll maneuvers.)

The high-pass washouts on lateral beam travel (y_{beam}) were of the general form:

$$\frac{y_{\text{beam}}}{y_{\text{free flight}}} = \frac{K_y s^2}{s^2 + 2\zeta_y \omega_y s + \omega_y^2}$$

where K_y = attenuation factor, ω_y = high-pass break frequency (r/s), and $\zeta_y = 0.70$ (fixed).

Values of K_y and ω_y were explored, from which example data will be shown subsequently. A nonlinear (time varying) washout was also tested in which ω_y was continuously adjusted in accordance with the smoothed magnitude of roll angle so as to permit correct cues for small roll activity, while reducing the lateral beam travel peaks for large roll angles. Reshaping the forcing functions was also investigated and shown to reduce travel requirements.

The pilot's task was to follow an evasive (randomly rolling) target while suppressing gust disturbances (Ref. 81). A two-independent-input technique produced behavioral data (describing functions) and performance data (error and control scores), which revealed how pilots used the visual

and motion cues. Subjective data was also gathered on the tracking task as well as on limited "sidestep" maneuvers. Appendix B herein presents the results from Ref. 79.

The main results in Ref. 79 show that:

1. Both the pilots and previous well-trained non-pilots (Ref. 81) exhibited nearly identical behavior and performance, implying universality of adaptation and results.
2. The pilots' roll tracking behavior and performance were not significantly affected by a variety of lateral-sway washouts.
3. The nonlinear lateral washout filter reduced the peak lateral travels at the expense of occasionally greater lateral-specific-force (a_y) peaks, but otherwise did not affect behavior or performance. It promises to provide an adaptive washout which does not need to be iteratively fine-tuned to avoid hitting stops while minimizing spurious washout artifacts. Additionally, it should be especially useful during training, where motion cue usage is changing.
4. Both sidestep and random tracking maneuvers gave rise to spurious lateral motion cues (the coordinated free-flight case would have none) which were characterized as "out-of-phase," "like a student on the rudder pedals," etc. Analysis showed these to be roughly correlated by time- and frequency-response parameters related to sway washout gain, K_y , and frequency, ω_y . Combinations of K_y and ω_y were identified which provided the most acceptable impressions of roll and sway motion realism.

D. ILLUSIONS AND DISORIENTATION

The final factor we wish to consider is that dealing with illusions and pilot disorientation. Here we have assumed that "real-world" illusions are not to be intentionally duplicated in the simulator. The reason for this is that the majority of these illusions require sustained angular rates or linear accelerations. Consequently the ability to duplicate these motions would be very costly, and there already exist special purpose devices which are available for investigating these problems. The

problem we are concerned with here is how to avoid any artificial illusions which might be introduced by the limitations of the simulator dynamics.

The main difficulty here is any discrepancies which might arise between the visual and motion senses, especially for the case of simulated visual flight. The problem of vertigo was discussed in Section III in connection with the visual field of view of a fixed base simulator. An example of this is reported in Ref. 84. In those experiments, a fixed-base simulator with a wide angle projection system was used to simulate a hovering VTOL. If the pilot made rapid maneuvers with large angular motions, he became nauseated after a short period of time. The conflict between the visual presentation which told the pilot he was rotating rapidly in space and his lack of vestibular cues was apparently the cause. Apparently the magnitude of the angular motion is one of the governing factors here. (The other governing factor is the field of view of the visual display as discussed in Section III.). On the one hand, there have been a number of fixed-base simulations of transport landings with similar displays in which there was no problem. On the other hand there have been many fixed-base simulations of instrument flight with large angular motions in which there was no problem of nausea either.

These results lead one to conclude that if the simulator is to be used for visual tasks in which there would be large angular motions, e.g., a sidestep maneuver for the purpose of collision avoidance on a landing approach with parallel runways*, it would be necessary to have the angular motion cues, and some limited translational motion would also probably be helpful. This could be a very significant factor in the motion simulator design, in that one would have to have the capability of providing at least the angular and limited translational motions for the sidestep while utilizing the visual display. For the majority of operations with limited

* The side step maneuver during landing is discussed in Ref. 82. A typical upper bound on roll attitude is 40 deg, whereas maximum roll rate is only 20 deg/sec.

forward view, motion cues are probably not so critical from the illusion standpoint as from other (e.g., tracking) and failure detection considerations.

E. SUMMARY

Fidelity requirements for the simulation of cockpit motion depend on the psychomotor role of motion cues in tracking and failure detection tasks as well as on the pilot's impressions of realism.

With regard to the pilot's tracking performance and behavior, it is generally more important to reproduce correct rotational motion cues over an appropriate frequency range which will be predicted from validated analysis of the specific tracking situation using the Multimodality Pilot Model and, if necessary, the Multiloop Pilot Model. Nevertheless one must be cautious about providing only rotational motion cues in a simulator (which are potentially useful to the pilot) but which are not present in actual flight without corresponding specific forces which accompany translation.

The simulation of motions accompanying a failure will help greatly in the pilot's timely detection of the failure. This is especially true if the visual modality is already heavily loaded with a demanding task. At the very least the motion should be sufficient to provide an unambiguous clue to the failure. In many cases failure detection may put the most demanding requirement on translational motions.

Two specific problems which compromise the pilot's impressions of realism are false translational accelerations and washout effects on open-loop maneuvers. Roll motion without sway motion provides an exaggerated proportional gravitational component of lateral acceleration which is unrealistic. An example of the washout problem is provided by a pull-up maneuver in a simulator with limited vertical displacement. Although the initial acceleration would be correct, it would be necessary to reverse the acceleration unrealistically because of the limited travel.

Roll and sway motion cues have recently been investigated with the aid of the Air Force Flight Dynamics Laboratory's Large Amplitude Multimode Aerospace Research Simulator (LAMARS). Various linear and nonlinear sway motion washout filters were designed and tested to keep the sway displacement within the ± 10 ft of LAMARS travel. The main results from this investigation show that:

- The pilots' roll tracking behavior and performance were not significantly affected by a variety of lateral-sway washouts.
- The nonlinear lateral washout filter reduced the peak lateral travels at the expense of occasionally greater lateral-specific-force (a_y) peaks, but otherwise did not affect behavior or performance. It promises to provide an adaptive washout which does not need to be iteratively fine-tuned to avoid hitting stops while minimizing spurious washout artifacts. Additionally it should be especially useful during training where motion cue usage is changed.
- Both sidestep and random tracking maneuvers gave rise to spurious lateral motion cues (the coordinated free-flight case would have none) which were characterized as "out-of-phase," "like a student on the rudder pedals," etc. Analysis showed these to be roughly correlated by time- and frequency-response parameters related to sway washout gain, K_y , and frequency, ω_y . Combinations of K_y and ω_y were identified which provided the most acceptable impressions of roll and sway motion realism.

F. RECOMMENDED MOTION SIMULATION SYSTEM

Based on the foregoing considerations a specific set of motion-cue requirements has been derived and is presented in Table 15.

The basic system should be a five-degree-of-freedom system (vertical and lateral translation; pitch, yaw, and roll rotation). We believe that for the applications of the MVSRRF, there is not enough need for longitudinal motion cues to justify six degrees of freedom. The main loss would be transient axial accelerations accompanying reverse thrust or spoiler operation, and these could be simulated by rotating the cab 90 deg in yaw so that lateral translation becomes axial translation. Steady

TABLE 15
MOTION SYSTEM DESIGN REQUIREMENTS

Degree of Freedom	Vertical	Lateral	Pitch	Roll	Yaw
Travel: desired (min)	$\pm 10'$ ($\pm 5'$)	$\pm 10'$ ($\pm 5'$)	$(\pm 30^\circ)$	$(\pm 45^\circ)$	$(\pm 30^\circ)$
Frequency Responses at 50% travel:					
a. Flat to:	1 Hz	1 Hz	2 Hz	2 Hz	2 Hz
b. Effective time delay	< 0.2 sec	< 0.2 sec	< 0.1 sec	< 0.1 sec	< 0.1 sec
c. Damping of main modes	$\zeta > 0.5$	$\zeta > 0.5$	$\zeta > 0.5$	$\zeta > 0.5$	$\zeta > 0.5$

climb or dive axial accelerations could be simulated by tilting the cab, as is done for steady transverse acceleration (e.g., Fig. 8).

The toughest requirement is for ± 5 to ± 10 ft of translation, with a very smooth drive, and flat. As shown in Table 15, the required minimum angular travels vary from 30 deg in pitch or yaw to 45 deg in roll, with a bandwidth requirement of 2 Hz. Minimizing the motion simulation lags is much more important than matching amplitudes in the region of human vestibular response frequencies. About 0.1 sec of net lag is specified, based on our experience with various simulators. Adequate load stiffness, weight compensators, and excess hydraulic drive capacity can help to reduce motion lag.

The drives must be very smooth and as noise-free as possible. Spurious vibrations and bending modes should be avoided by adopting a very light, rigid structure and avoiding large cantilevered masses (such as the Norair arm). Pilots are quick to detect any hydraulic drive noises which offer cues to the true simulator motion, so these must be minimized by acoustic isolation and damping, or by masking earphone noise.

We envision a pair of very light flight decks, each with its own "simulated window" visual display, which can be placed on the motion platform or used as fixed-base simulators. The motion system should be arranged to fit this concept, including the ability to rotate the cab in yaw for axial motion investigations. The coordinates of the rotation system should match the Euler angle conventions of the equations of motion. This will reduce the need for complex resolving operations. Provisions should also be made to adjust the instantaneous axes of rotation through a wide range.

More detailed quantitative requirements cannot be generated until a specific motion system concept is laid out. It is suggested that a motion system with vertical and lateral tracks mounted on a wall might be a good starting point for the next phase of this problem.

SECTION V

ASSESSING THE FIDELITY OF VEHICLE AND ENVIRONMENTAL MODELS

The problem of assessing the fidelity of dynamic vehicle and environmental simulator models lies in knowing what essential features produce correct system performance and, in the case of a piloted simulation, what features induce correct pilot behavior. It is these essential features which then must be checked using the best available information.

We must recognize that fairly complex simulator models are used at Ames Research Center for describing aircraft operating over wide ranges of flight conditions and loading configurations. But simulator model complexity, by itself, does not automatically guarantee fidelity, although it does escalate digital computation requirements for processing speed and storage. In fact, a complex model may tend to discourage validation attempts because it calculates the physics instead of simulating the physics. Our approach to model validation, however, allows us to work with a complex model having many degrees of freedom and non-linearities, but only because we effectively reduce complexity to the essential features mentioned above.

This is a practical concept for three reasons. First it involves consideration of a reasonable number of numerical quantities — say less than a dozen. Clearly validation of literally hundreds and sometimes thousands of simulator model parameters is simply impossible. It is far more effective to look at the net results which are of practical consequence to the pilot-in-control.

The second reason for considering only the essential model features is that it forces the simulator user to understand thoroughly his models by systematically reducing the model complexity to a point which is easily manageable.

The third reason for considering only the essential model features is that the reduced complexity of the model can, in turn, reduce the digital computation requirements for processing speed and storage. More will be said about this in Section VI.

We should note that the approach described here has been used successfully in connection with powered-lift certification, specifically, the development of proposed certification standards (Ref. 85). In order to formulate meaningful metrics it was necessary to reduce the complex models of powered-lift aircraft and their operating environment to more manageable forms. This, in turn, exposed the features which really mattered in a given situation, and led to direct determination of numerical tolerances on fidelity of the vehicle and environmental models.

Also the determination of essential features has been applied to helicopter dynamics modeled via the Bell C-81 Rotorcraft Flight Simulation Computer Program (Ref. 86). This specific application produced direct measures of basic attitude and heading control, pitch-roll cross-coupling, turn coordination, velocity and position control, and gust/wind-shear sensitivity. In each case there were found to be three or fewer essential features which defined the particular phenomenon of interest. It is these few features on which one would concentrate to demonstrate simulator model fidelity.

The following paragraphs describe this approach to assessment of simulator model fidelity by considering two useful examples. These examples involve the combination of pilot, vehicle, and wind environment. They also apply to the situation involving an autopilot in place of the human pilot. Further they apply to real time or nonreal time simulation.

Briefly stated, we view assessment of model fidelity by systematically reducing mathematical model complexity of the pilot (or autopilot), vehicle, and wind disturbance combination for a given condition. One example of this reduction process may begin with Step 1 following and proceed through Step 3.

Step 1, Full blown simulator model consisting of:

- Non-linear aerodynamics
- Complete autopilot and stability augmentation description
- Standard non-linear wind shear hazard and random turbulence model

Step 2, Linearized but high order coupled longitudinal-lateral-directional models of important components including pilot actions with:

- Six or more degrees of freedom of vehicle aerodynamics
- Linearized autopilot and stability augmentation including actuator and sensor dynamics
- Wind separated into linearized deterministic and linearized random components
- Linear pilot model of inner loop attitude and heading control and outer loop velocity or position control

Step 3, Lowest possible order combined pilot (or autopilot), vehicle, and environmental model with:

- Cross coupling and high frequency effects appropriately embedded
- Only significant disturbance components
- Three or fewer degrees of freedom in essential feature descriptions.

To be more specific, consider the cases of an aircraft operating IFR in a severe wind environment. Further let us concentrate on longitudinal vehicle performance in terms of altitude and airspeed. The question then is: what are the essential vehicle and environmental features which should be checked in the simulator?

A. SIMPLIFIED CTOL PILOT-VEHICLE DYNAMICS

The key to describing the predominant effects of wind shear on aircraft motion is to utilize pitch-constrained equations of motion. In effect, we assume that the pilot can instantaneously obtain any pitch attitude he commands, and that gusts have no effect on pitch attitude (i.e., pitch attitude is, itself, an independent control). These are not valid assumptions if one is concerned about pitching motion, per se, but they are reasonably valid if flight path and airspeed are the main concern

as in the case here. Further pitching motion can be handled as a second order effect within the simplified context, if desired.

The detailed derivation of simplified pilot-vehicle dynamics is carried out in Appendix C of Ref. 86. The starting point, however, is worth stating here in terms of the following equations of motion:

$$\begin{bmatrix} s - X_u & X_w s \\ Z_u & s(s - Z_w) \end{bmatrix} \begin{bmatrix} u_a \\ \Delta h \end{bmatrix} = \begin{bmatrix} (X_\alpha - g) & X_{\delta_T} & s & -X_w \\ -Z_\alpha & -Z_{\delta_T} & 0 & Z_w \end{bmatrix} \begin{bmatrix} \theta \\ \delta_T \\ u_g \\ w_g \end{bmatrix}$$

with

$$\left. \begin{aligned} \delta_T &= -K_u u_a \\ \theta &= -K_d \Delta h \end{aligned} \right\} \begin{array}{l} \text{Pilot's CTOL} \\ \text{technique} \end{array}$$

or

$$\left. \begin{aligned} \delta_T &= -K_d \Delta h \\ \theta &= -K_u u_a \end{aligned} \right\} \begin{array}{l} \text{Pilot's STOL} \\ \text{technique} \end{array}$$

The first benefit of this description is that we have vastly reduced the number of essential variables which describe even the linearized vehicle. Note that the airspeed and flight path motion due to attitude, throttle, horizontal gusts, and vertical gusts is dependent only upon the six parameters X_u , X_w , Z_u , Z_w , V , and $X_{\delta_T}/Z_{\delta_T}$ ($X_\alpha = V X_w$ and $Z_\alpha = V Z_w$). Each of these is easily estimated as demonstrated in Ref. 87. Two pilot

parameters are involved, K_u and K_d . These are set directly in proportion to their respective control loop tightness as expressed by crossover frequencies, ω_{c_u} and ω_{c_d} . For the CTOL case:

$$K_u X_{\delta_T} \doteq \omega_{c_u}$$

and

$$-K_d Z_\alpha \doteq \omega_{c_d}$$

The altitude response due to horizontal and vertical gusts can be expressed in the following generic forms:

$$\frac{\Delta h}{u_g} \doteq \frac{-\frac{2g}{V} s}{\left(s + \frac{1}{T_u}\right)(s^2 + 2\zeta_d \omega_d s + \omega_d^2)}$$

or

$$\frac{\Delta h}{\dot{u}_g} \doteq \frac{-\frac{2g}{V}}{\left(s + \frac{1}{T_u}\right)(s^2 + 2\zeta_d \omega_d s + \omega_d^2)}$$

and

$$\frac{\Delta h}{w_g} \doteq \frac{Z_w \left(s + \frac{1}{T_u} - X_u + \frac{X_w}{Z_w} Z_u\right)}{(s^2 + 2\zeta_d \omega_d s + \omega_d^2) \left(s + \frac{1}{T_u}\right)}$$

$$= \frac{Z_w}{(s^2 + 2\zeta_d \omega_d s + \omega_d^2)}$$

where

$$\frac{1}{T_u} \doteq \omega_{c_u}$$

$$\omega_d^2 \doteq \omega_{c_d}^2 \left[1 + \frac{Z_u (X_\alpha - g)}{\omega_{c_u} Z_d} \right]$$

and $2\tau_d \omega_d \dot{z} = -X_u - Z_w$

These expressions can be sketched in terms of asymptotes for the amplitude response to horizontal gust velocity, u_g , horizontal gust acceleration or rate of shear, \dot{u}_g , and vertical gust velocity, w_g , as shown in Fig. 9. Accordingly altitude response to horizontal wind shear is inversely proportional to:

- Airspeed, V
- Airspeed loop tightness (ω_{c_u})
- Square of flight path loop tightness ($\omega_{c_d}^2$)

for the spectral region extending out to the flight path regulation mode at frequency ω_d . Altitude response to vertical gust velocity is inversely proportional to:

- Square of flight path loop tightness ($\omega_{c_d}^2$)

and directly proportional to:

- Heave damping, Z_w , which, in turn, is proportional to:
- Airspeed, V
- Lift curve slope, C_{L_α}

and inversely proportional to:

- Wing loading, W/S (Refer to the definition of Z_w in the glossary.)

These results will be useful for aiding in the interpretation of analogous results to be presented in the next topic.

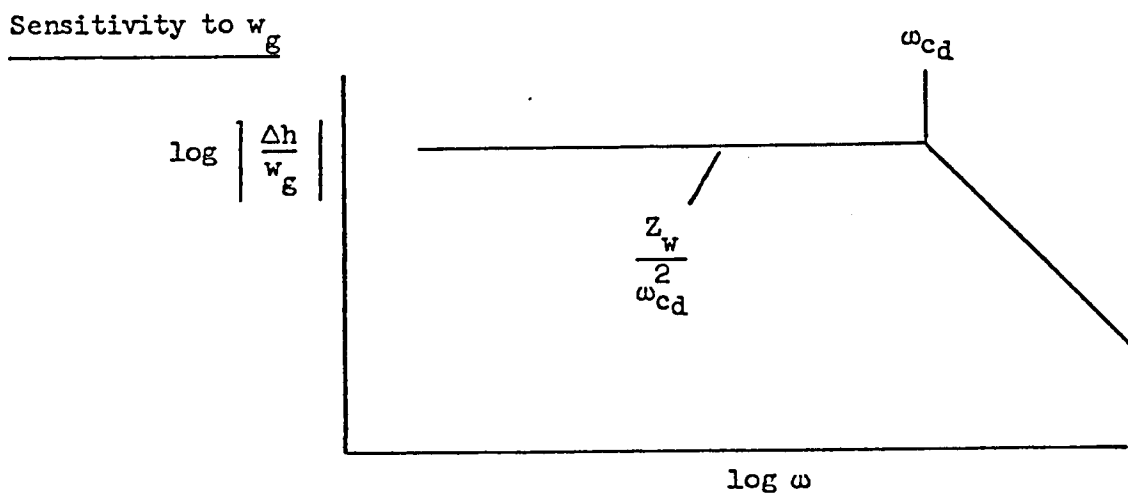
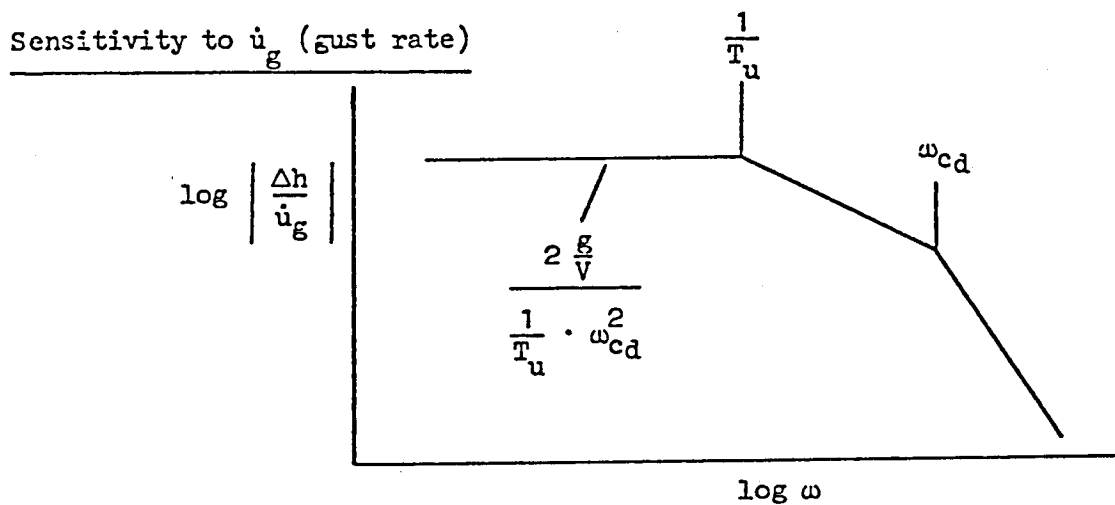
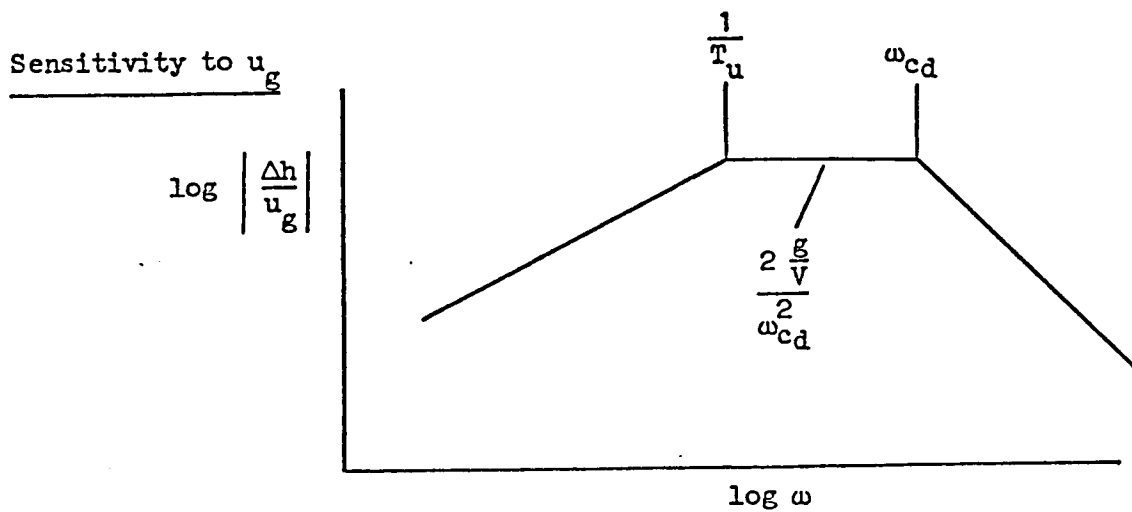

Figure 9. Asymptotes of Amplitude Response of Altitude Change Due to Gusts

B. SIMPLIFIED STOL PILOT-VEHICLE DYNAMICS

The block diagram which describes the STOL piloting technique is shown in Fig. 10.

This is reducible by direct multiloop analysis in which the manual crossover model for the pilot's STOL technique is appropriately applied. (This also applies to the use of an autopilot.) If we were to concentrate on the essential feature of outer loop longitudinal-vertical control, one key relationship would be altitude or flight path sensitivity to longitudinal and vertical gusts*. The resulting essential-feature transfer function expressions are:

$$\frac{\Delta h}{u_g} = \frac{(Z_u + \omega_u \frac{VZ_w}{g})s}{(s + \omega_u)(s^2 - Z_w s + \omega_h^2)}$$

and

$$\frac{\Delta h}{w_g} = \frac{Z_w}{s^2 - Z_w s + \omega_h^2}$$

A sketch of height response amplitude asymptotes is instructive, therefore Fig. 11 is presented.

The essential parameters in terms of vehicle and pilot/autopilot are, therefore:

Vehicle: Z_u — A function of airspeed which peaks at about 20 to 30 kt but is relatively small elsewhere. Note that it determines basic height sensitivity to longitudinal gusts.

* A counterpart to this example is given in Ref. 87 for conventional aircraft flying into large wind shears.

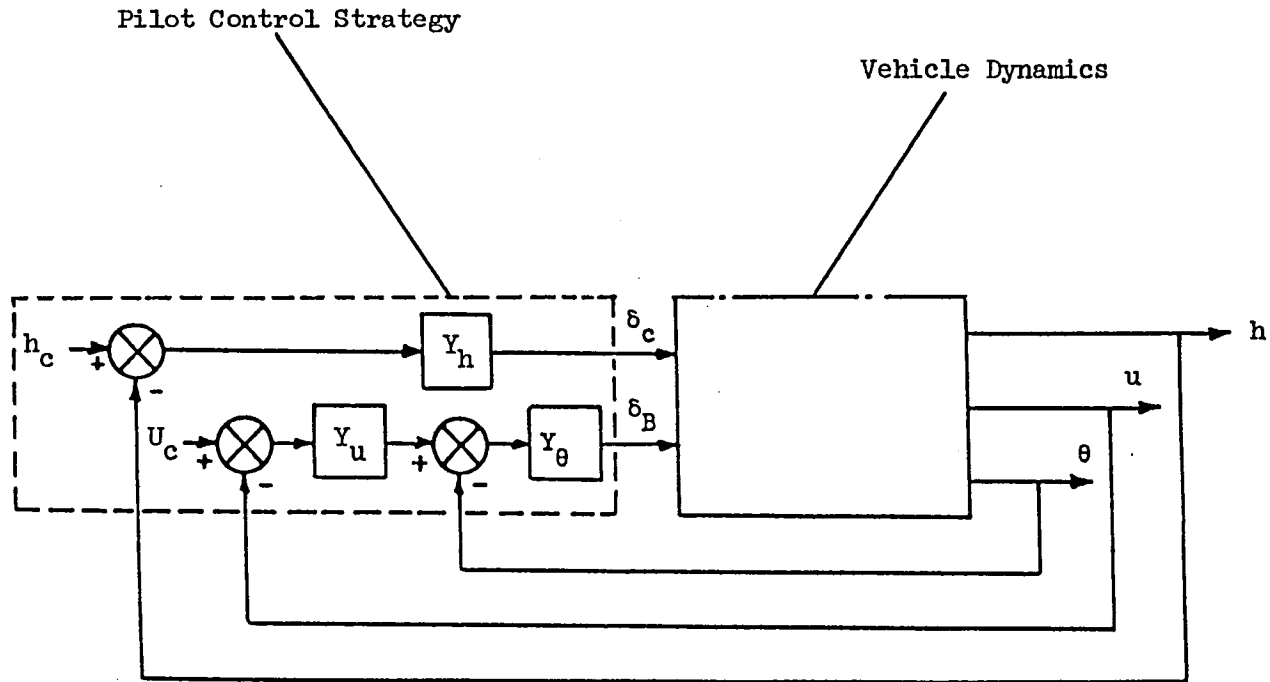

Figure 10. Assumed Pilot-Vehicle Loop Structure for Longitudinal-Vertical Control in Low Speed Flight

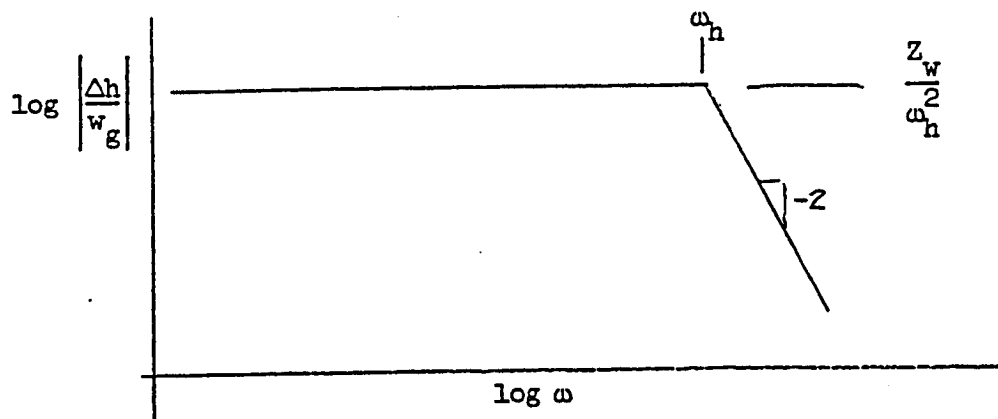
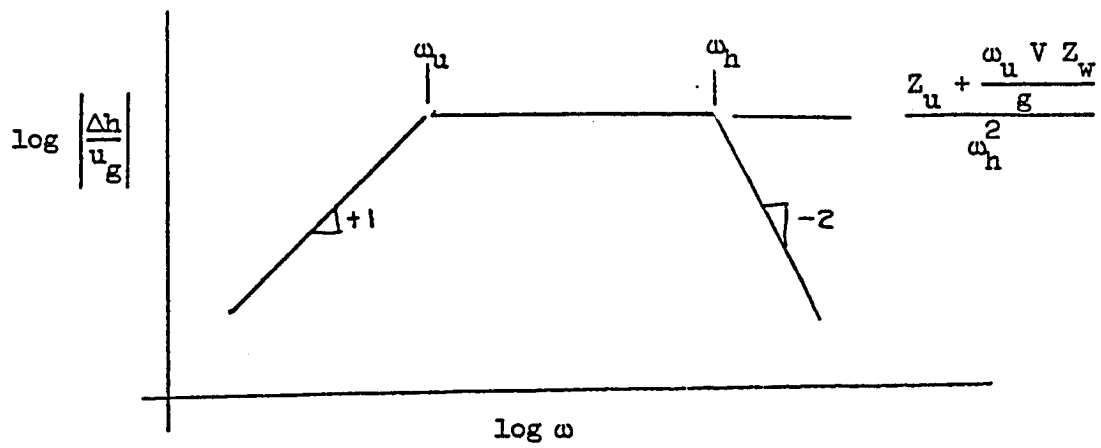

Figure 11. Height Response Amplitude Asymptotes for Gust Disturbances

Z_w — Heave damping which also is a function of airspeed but is always significant. It determines basic height sensitivity to vertical gusts as well as damping in the primary height response mode.

Pilot/Autopilot:

ω_u — Lower band limit to longitudinal gust sensitivity as well as contributor to Z_u effect (via product

$$\frac{\omega_u V Z_w}{g}$$

ω_h — Upper band limit to height response for both gust components and determinant of peak response for both gust components.

The implications which the above relationships have for the atmospheric disturbance model are:

- Only the ω_g frequency content between ω_u and ω_h affects the simulator model. (Frequency content tends to be centered about the ratio of airspeed, V , to gust scale length, L_u .)
- All ω_g frequency content up to ω_h affects the simulator model.
- Steady time dependent wind shears having a duration of more than $1/\omega_u$ seconds will affect the simulator model significantly.
- Steady altitude dependent wind shears will have only a moderate effect unless ω_u is zero, i.e., there is no airspeed regulation.

Finally the validation task is clear for the longitudinal-vertical outer-loop aspects of simulation. The task is simply to insure that the effective values of Z_u and Z_w are correct. These are directly obtainable from the simulator computer via perturbation of the z-force by airspeed and vertical velocity. Also each is relatively easily obtained from flight test data. If an autopilot is involved then ω_u and ω_h can be

easily determined from response to airspeed and altitude hold commands. For an actual pilot, ranges of likely ω_u and ω_h can be determined from existing experimental data (e.g., Ref. 54). Furthermore, the actual ω_u and ω_h demonstrated by the pilot in the simulator are relatively easily obtained by the measurement methods described in Ref. 2.

C. SUMMARY

To summarize the ideas in this section regarding assessment of vehicle and environmental model fidelity, let us return to the original concept. That is, we concentrate on validating only those essential features which produce correct system performance and induce correct pilot behavior. This vastly streamlines the validation procedure and forces the simulator user to understand very well what are the significant model components and features. The key to finding the essential model features is the reduction of complex pilot-vehicle-disturbance models via existing multiloop system analysis methods. Finally the methodology for so reducing complex systems has been applied repeatedly and has attained a high level of refinement.

SECTION VI

COMPUTER SELECTION CONSIDERATIONS

A. DIGITAL SYSTEMS

There are a number of commercial digital computer systems which are capable of performing the modular computational functions described in Section I for the proposed facility. The function of each host computer described in the block diagram of Fig. 1 (in Section I) is two fold: first, each host performs the designated aircraft or air traffic control simulation in real time, and second, each host provides essential information from the aircraft or air traffic control simulation to the co-operating portions of the MVSRF described in Fig. 1, viz.; the flight decks; traffic controllers' and experimenters' consoles; and data acquisition systems. Reference 3 has already recognized that the substantial requirements for program development and real-time simulation are best satisfied by separate facilities; thus, it is not intended that any host computer will be burdened with timeshared or batch operations for program development.

Existing host computer requirements in the Flight Simulator for Advanced Aircraft (Ref. 88) at Ames Research Center are provided by the Xerox Sigma-8 digital computer, some characteristics of which are listed in Table 16. References 3 and 5 claim to have analyzed existing flight simulation requirements and projected future requirements in arriving at the recommendations in the fifth column of Table 16 for each of the host computers in Fig. 1. Examples of comparable commercially available digital computers are also listed in Table 16. References 3 and 5 arrive at the conclusion that the DEC VAX-11 family compares very favorably with simulation computers at Ames Research Center and meets all of the stated requirements. The VAX 11/780, however, requires a floating point accelerator in order to provide the execution times listed. Characteristics of DEC's new VAX 11/750, which is significantly less expensive than the VAX 11/780, are also listed. It should be noted that the execution times for

TABLE 16

COMPARISON OF SOME HOST COMPUTER SYSTEMS EMPLOYING 32-BIT WORDS
WITH RECOMMENDED REQUIREMENTS FROM REFS. 3 AND 5

Type	Ames Research Center			DEC PDP 11/70	Recommended Requirements (Refs. 3, 5)	DEC VAX 11/780	DEC VAX 11/750
	XDS Sigma 7	XDS Sigma 8	XDS Sigma 9III (Bldg 239)				
Core Size (32 bit words)	128K	128K	160K	500K	> 333K	1M	1M
Key execution time (single precision floating point)							
Store (μ s)	2.6	1.53	1.53	1.5*	<1.5	1.2†	1.9§
Add (μ s)	3.3-8.2	2.25-5.00	2.25-5.00	1.7*		0.8†	8.9§
Multiply (μ s)	6.0-8.8	3.97-6.05	3.97-6.0	3.4*	<2.0	1.2†	12.6§
Range of Execution Rates (Mega FLOPS#)	0.2-0.4	0.1-0.6	0.2-0.8	0.2-0.8	1		

* With FP 11C floating point processor which runs under RSX-11M/FORTRAN IV-PLUS.

† With floating point accelerator.

§ Without floating point accelerator. Improvements with this are expected to be approximately 3 μ s for multiply and approximately 4 μ s for add.

Million Floating point Operations/Second (Ref. 5)

the VAX 11/750 are without a floating point accelerator. The likely improvement on these times is given in the table footnote.

As we mentioned in Section V, it is customary at Ames Research Center to employ fairly complex mathematical models for aircraft simulation over wide ranges of flight conditions and loading configurations. In the words of Ref. 5, it is customary to "calculate the physics explicitly, rather than to simulate the essential features of the physics." The reason usually given for this practice is actually misleading, viz., that simulator model complexity must inherently assure fidelity. Although (as mentioned in Section V) this practice certainly escalates digital computer requirements for processing speed and storage, simulator model complexity is counterproductive because it discourages genuine attempts at validation. Consequently we and others have repeatedly witnessed flight simulations with deficient fidelity, because it was taken for granted that the complexity of the mathematical model of the physics somehow assured fidelity, and there was not time to diagnose the source of the deficiency when some deficiency was discovered during training after the experiment was in progress.

There is no need to employ complex mathematical models of the physics of flight in the MVSREF. Much simpler models which simulate the essential features of the physics will suffice. Examples of simpler models which have been validated are given in Refs. 89 and 90. Real time computations for these models can be accommodated in any of the 16-bit word minicomputers listed in Table 17 with processing time to spare for simulating the essential features of other aircraft systems and for providing real-time data acquisition. Before any computer is selected, however, a benchmark simulation program such as that in Ref. 90, should be written and executed on each of the prospective candidates. Recommendations for organization of the software are given subsequently in Section VII.

Several factors involved in selecting computational module(s) from among possible candidates are summarized in Table 17 for some typical competing possibilities. One of these computing systems is the Varian 73 which is employed in the VITAL III CGI system (Table 13, Section III). Another is the PDP 11/45 which is used in the Evans and Sutherland

TABLE 17

COMPARISON OF MINICOMPUTER SYSTEMS EMPLOYING 16-BIT WORDS

Name:	NOVA 312	ECLIPSE 230	FDP 11/34 (see footnote for FDP 11/45)	VARIAN 73 Sperry Univac formerly Varian Data Machines**
Manufacturer:	Data General Corp.	Data General Corp.	Digital Equipment	
Price Range ¹ :	10-40K\$	21-91K\$	12-44K\$	~55K\$
Processor				
• Size instruction set	2024	2024	400	159
• Speed, access	700 nsec	400 nsec effective ¹	900 nsec	660 nsec
• Special hardware	either integer multiply/divide or floating point	parallel floating point	either integer multiply/divide or floating point	floating point available
• No. of general purpose registers	4	4	6	3
Memory				
• Word size	16 bit	16 bit	16-18 bits	16 bit
• Memory size	32-128 kwords	32-128 kwords	32-128 kwords	8-32 kwords
• Other	uses memory management and multi-core-adaptor, core-to-core transactions at 1000 nsec	uses memory interleaving, error checking, and correcting	uses memory management	dual port, or core sharing at 660 nsec
I/O Capability				
• Clock programmable	yes	yes	yes	yes
• No. of interrupt levels	64	64	4, vectored	64
• No. of parallel channels	62	62	unlimited	32
Peripherals	good industry support	good industry support	industry standard for most peripherals	weak to moderate support
Software				
• Operating system	RDCS (E) ¹	RDCS (E) ¹	RT-11 (E), RSX-11M (E), RSTS/E (E)	yes
• Languages	FORTRAN (E), COBOL (E), BASIC	FORTRAN (E), COBOL (E), BASIC	FORTRAN (E), BASIC (E), COBOL (E)	FORTRAN, RPG IV
• Peripheral controllers	"SAM", Fortran subroutines	"SAM", Fortran subroutines	Fortran extensions	Vortex
• Diagnostics	yes	yes	yes	yes
• Support, documentation	good	good	good	fair
Software Support, Reliability, Service	moderate-large volume	moderate-large volume	large number of real-time applications in U.S. Service contract @ 1.5% of purchase price per month	moderate number of Laboratory applications but declining

* These prices include minimal software but exclusive of peripherals and interface requirements as there are generally vendors which supply these at lower costs.

¹ Uses memory interleaving; integer multiply/divide is standard

² (x) Datamation, Vol. 25, No. 14, Dec., 1979, "overall satisfaction" from user rating of software packages, HR-Honor Roll, HM-Honorable Mention, E-Excellent, F-Fair, G-Good.

³ The 11/34 offers Unibus architecture whereas the 11/45 offers multiple bus architecture for a higher overall data throughput rate. Other data for the 11/45 are: 40K\$ and up price range; 400+ double operand instructions; 300 nsec processor access time; independent (single or double precision) floating point processor; up to 12K words memory; 300 nsec Bipolar, 495 nsec MOS or 900 nsec core memory; with RSX-11D and -M real-time multi-user and RSTS/E timesharing operating systems. However, the 11/34 offers sufficient memory and speed for AIDE applications.

** Owned by Univac Division of Sperry-Rand Corp. as of July 1977.

Day/Night CGI System (Table 13). The common denominator among the two DEC and two Data General computing systems is the real-time operating system with high-level languages, good supporting documentation, and software diagnostics. All four of these computing systems also have become available in moderate-to-large numbers of real-time and laboratory applications. To make a cost-effective selection among such alternatives we must consider the requirements unique to the real-time graphics generation task in general as well as the computational needs pertaining to each functional subsystem. Some of these factors are discussed below.

One concept which we have found useful in satisfying the computational requirements in experimental facilities is distributed processing. This allows modularization of computational and control hardware, whether hybrid (see later discussion) or digital, along functional lines such that each module can at least partially function independently. Our experience indicates that this can have many advantages, e.g.,

- Parallel development. Hardware specification and procurement and software design and checkout can be done in parallel for each module.
- Checkout. Independent design tests, routine diagnostic tests, and maintenance on both hardware and software are possible.
- Reliability. Down time for the entire facility may be minimized. Failure of one computational unit might still permit the possibility of part-task operation of the system.
- Flexibility. Changes in, additions to, and reconfigurations of the system are possible at lower cost than if the total system is centralized.
- Commonality. Distributed identical computer modules (two or more) offer some cost saving and efficiency enhancement, e.g., in spares, accessories, software support, etc.

A potential weakness of distributed processing is reduction in total operating speeds. This can be avoided by proper modularization along functional lines to insure that the amount of data being transferred

between processors is minimized. Advantage can also be taken of recent hardware developments. For example, display generation hardware has evolved to include the use of "smart terminals" — terminals with their own local high-speed update computation hardware and memory. In addition, computer cpu, memory, and interface speeds have increased in general and core-sharing technology is available if necessary, e.g., the Nova 312 and Varian 73 in Table 18. (The VITAL system, Ref. 91, uses this feature of the Varian 73 and 76.) Such developments, coupled with an enhanced appreciation for the necessary computational speeds of the dynamic elements and modes involved, make modularizing the computational requirements a viable alternative to a centralized host system.

Another major consideration in selecting computers for use in any environment is the available software. Typically, research facilities consume extensive engineering manhours throughout their life to develop and change the original system's performance. Software costs soon surpass hardware costs. Therefore software should be selected which is of as high a level as possible yet flexible enough to include assembly language modules for high-speed data handling. A popular method of dealing with this requirement is for the machine to enable assembly of MACRO subroutines as part of a FORTRAN program. An alternative approach is to use high-level languages which, when compiled, result in assembly language codes which can then be assembled and linked. Some of these languages, e.g., PASCAL, have demonstrated a two- or three-times faster speed than FORTRAN.

In addition, a real-time operating system for efficient program and file handling and multiprogramming for simultaneous program development is desirable. As also shown in Table 17, most manufacturers provide this type of software, but the utility and the quality of documentation and support varies. Only the larger minicomputer manufacturers are willing to provide frequent documentation of required "patches" to fix "bugs" as the software matures.

One of the requirements germane to this effort is the compatibility of at least one of the computers with the CGI display system(s) discussed in Section III. This generally adds to the computational system selection

factors the desirability of the options for high-speed access to core and parallel processing. Even though recent developments in digital display systems are handling high update rate requirements with local micro-processors and core, the dynamic requirements of the vehicle being represented may require frequent changes in display format. Increasing the fidelity of the visual scene will also generally increase the core requirements for the host computer. This additional requirement can be met by providing a high-speed interface and the option of high-speed expandable memory. Most display system manufacturers develop the interfaces for one or more minicomputers. Thus to eliminate the cost of developing a special-purpose interface, it helps to select a computer with which the display implementation is already compatible (e.g., see DEC PDP-11 family in Table 17).

It also adds to the flexibility of the system to select a computer which has optional memory speeds. These will range from non-volatile core memory through high density, low power MOS memory to high-speed bipolar memory. Another factor is the speed of the memory management system. For certain types of computations the "bit-byte-block" memory control approach (e.g., see Eclipse S230 in Table 17) substantially decreases average access time.

While tradeoff studies can become involved in the details of various host computer-display processor configurations, there are usually higher priority factors which are more subjective in nature to be considered. These include such intangibles as:

- Hardware/software reliability
- Reputation of the manufacturer for delivery, continued product expansion support, and growth/potential of the company
- Usage in applications of similar complexity
- Compatibility with existing facility components (including computers)
- Experience of the users with other computers of the same family
- Quality/cost of maintenance support.

Thus, in addition to evaluating quantitative information about existing computers such as provided in Table 17, several qualitative factors based on the experience of other users in the real-time simulation industry must be considered in selecting computational modules. Consideration of most of the qualitative factors listed above leads inevitably to a recommendation of the DEC PDP-11 family.

B. DIGITAL INTERFACES

It is desirable to use standard interfaces between all equipment in the facility. The four most promising candidates are:

- EAI Standard RS-232C (Ref. 92)
- ANSI/IEEE-STD 488-1975 (Ref. 93)
- ARINC 429-3 (Ref. 94)
- MIL-STD-1553A (Ref. 95)

From the standpoint of simplicity it appears preferable to use the serial RS-232C interface for all lower-speed (less than, say, 9600 baud) requirements and the parallel IEEE-STD 488 for higher-speed requirements. These two, in particular the RS-232C, are becoming more generally supported by manufacturers of computers and peripheral equipment and were considered preferable. The more complex ARINC 429-3 and MIL-STD-1553A can accommodate commercial and military operational avionics equipment, respectively, and are not necessary for the MVS RF as we envision it.

C. HYBRID SYSTEMS

The foregoing discussion and considerations are directed at digital computer hardware/software aspects which will lead to a preferred system structure and requirements specifications in the course of this effort. Alternatives to pure digital systems should also be considered depending on the nature of the test and evaluation research requirements which evolve for the facility. For example, requirements for accurate

reproduction of aeroelastic motions could lead to consideration of hybrid computations involving both analog and digital modules.

The tradeoff issues involved in hybrid (versus pure digital) implementation are an "apparent" loss of flexibility on the one hand and "continuous" update intervals on the other hand. Additional factors for comparison include extra D/A and A/D conversion hardware, relatively higher analog unreliability and maintenance, dynamic range limitations, and the mixture of skills required to operate the hybrid facility. Most of these issues are usually disadvantageous relative to pure digital. However an overriding favorable aspect of analog operations is computational speed which can be used effectively to reduce digital computer capacity and cycle time requirements, e.g., in Ref. 89. If these should become critical, and they may be for large interacting problems*, consideration of the hybrid approach is indicated.

Thus the impetus for a hybrid versus a pure digital system would stem basically from a research requirement for high fidelity, high frequency aeroelastic system dynamics and/or complex pilot/airframe/environmental interactions which could absorb excessive digital computer high-speed capacity. Depending on the priorities assigned to the computation requirements, hybrid candidates may be reconsidered in a future review of possible computers, if unforeseen cycle time limitations should develop. Such a review should consider existing general-purpose machines (e.g., the EAI series) as well as special-purpose designs. However, in view of the recommendations in Section III for computer-generated information (CGI) displays, hybrid computation is not recommended, because of the inherent reliance of CGI displays on digital computers.

* A recent fixed-wing moving-base piloted simulation for which STI provided technical and programming support involved modeling a rigid-body six-degree-of-freedom airplane. The simulation included encounters with arbitrarily located and parametrically characterized wake vortices, and strip theory computations of the vortex-induced forces and moments as a function of the resulting motions of the pilot-controlled aircraft. The initial cycle time of about 0.08 sec resulted in unrealistic pilot/aircraft response. To reduce cycle time to a barely acceptable 0.06 sec required fairly drastic truncation of the strip theory calculations to stay within computer capacity.

SECTION VII

SOFTWARE

This section describes the computer software recommended for the Man-Vehicle Systems Research Facility (MVSRF).

KEY CONSIDERATIONS

1. The objective of the facility is to investigate man-machine relationships which enhance flight safety by reduction of human error, not to simulate the mathematical physics of particular flight vehicles and systems in the complete details usually employed for handling quality investigations. The software development should therefore be constrained to satisfy this objective.
2. Computer hardware and software should closely parallel that in the Man-Vehicle Systems Branch of Life Sciences Division at Ames Research Center. Having an in-house consultant staff will prove invaluable, and no compromise of MVSRF objectives will result.
3. All possible software should be in a higher-level language. The only requirement for lower-level language is for input/output (I/O) handlers.

The MVSRF will require three levels of software, i.e.,

- The Computer Operating System
- The Experimenter's Executive
- The Real-Time Running Modules.

These are shown schematically in Fig. 12 and are discussed further below.

A. THE COMPUTER OPERATING SYSTEM

The operating system, including higher-level language translators, assemblers, editors, etc., will (with the exception of certain I/O handlers) be purchased software. The primary computers will likely be from the Digital Equipment Corporation (DEC) VAX-11 or PDP-11 family. Before

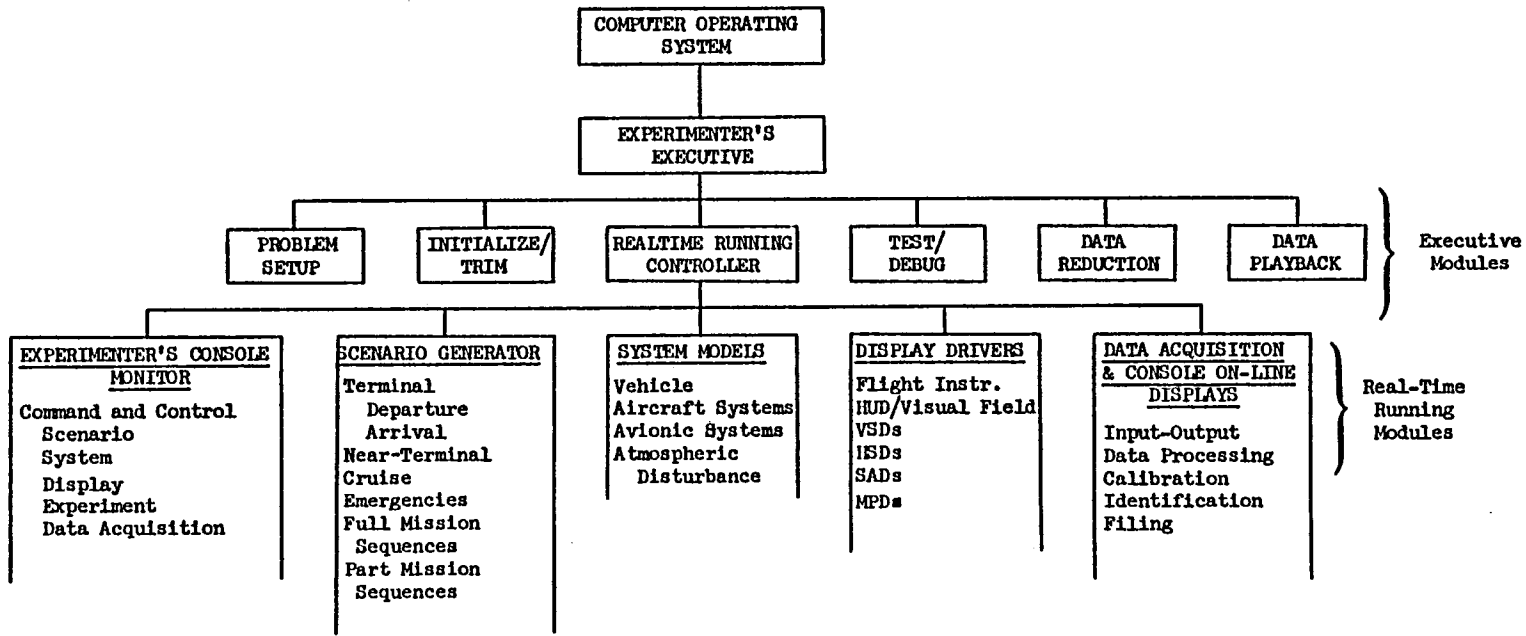

Figure 12. Facility Software Requirements for the Current and Advanced Technology Simulations

any computer is selected, as noted in Section VI, a benchmark simulation program should be written and executed on each of the prospective candidates. Besides VAX/VMS, the two most pertinent DEC operating systems are the single-user RT-11 and the multiuser RSX-11M. Both of the latter have been used for real-time simulation at NASA Ames Research Center. The major portion of software should be written in a higher-level language. DEC's RT-11/FORTRAN IV has deficiencies and in real-time operation is significantly slower than DEC's FORTRAN IV-PLUS which is available under RSX-11M but not RT-11. RSX-11M offers the multiuser capability which is essential for software development. The possibility of using the PASCAL language under RT-11 may, however, be preferable for real-time simulation.

B. THE EXPERIMENTER'S EXECUTIVE

The development of a comprehensive Experimenter's Executive will be the key to providing a user-oriented programmable facility. The Executive will be a collection of utility packages which will aid the experimenter in the design, development, and checkout of his problem and in the reduction of data obtained from the facility.

Problem Setup — This module will allow the user to select the appropriate real-time modules for his particular problem. It is expected that eventually there will be several versions available of real-time module types, e.g., fixed-wing and STOL vehicles. The Executive Setup mode will allow the user a simple means of activating the desired versions. The Setup mode will also allow the user to designate disk files which contain module parameter values, e.g., particular aircraft characteristics. Control of data acquisition and console on-line monitoring displays will be exercised via the Executive's Setup mode.

Initialize/Trim — This module will allow the user to control run-to-run conditions and parameter variations. It will exercise each of the selected real-time modules to set appropriate initial conditions and trim the vehicle dynamics to the selected starting flight condition.

Real-Time Running Controller — This module will control the timing sequence of the real-time modules. In addition to running the problem in actual, wall-clock, real time

it will have modes which will allow the experimenter to run the problem in "slow" time or in a single step-by-step fashion with the capability to stop the problem at any time, i.e., put the system in "hold." These latter modes are intended to aid the user in system checkout.

Test/Debug — This module will provide an automatic overall system test. It would be expected that the automatic test would be run prior to and after the completion of a set of runs, e.g., twice a day during the production running of a given problem. The Debug mode would be used in conjunction with the checkout modes of the Running Controller. It would allow the experimenter to display the value of any variable in any real-time module at the experimenter's console.

Data Reduction — This module will be the user's interface between the real-time data acquisition module and end-of-run or batch reduction programs. The module will have the capability to collect data both on an individual run basis and for a selected group of runs.

Data Playback — The data playback module will provide three operating capabilities, viz., (a) the full duplex data monitoring capability in real-time to the experimenter's console, (b) the accessing and output of partially processed or unprocessed end-of-run data which has been stored temporarily, and (c) the retrieval upon command at a later time from archival magnetic tape storage of data intended for further inspection or off-line processing on the facilities of Ames Research Center's Computation Division.

An additional Executive module, or perhaps a separate stand-alone program, not shown in Fig. 12, would be a utility package which would aid the user in setting up desired display formats. Although the recommended graphics generators in Table 11 (Section III) are driven by FORTRAN-callable subroutines, a higher-level interface between the user and the display would be desirable. The input to the graphics program would be a description of each symbol or element to appear on a given display with identification of its controlling variables. The program output would be a FORTRAN module which combines graphics generator calls with other required FORTRAN statements necessary to effect the desired display.

C. THE REAL-TIME RUNNING MODULES

1. Background

The real-time running modules of software for the current and advanced technology aircraft simulation host computers (defined in Fig. 1, Section I) will perform experimental control over the scenario. Hereinafter we shall simply refer to each of these computers as the "host" computer. The visual field and display graphics computers (Figs. 2 and 4 in Section I) and the data acquisition computer (within the experimenter's console, Figs. 2 and 4 in Section I) represent "satellite" computers with respect to the host computer. Except for flight instrumentation, the primary display driving modules will be embodied in the visual field and graphics computers. Alternatively, the flight instrumentation could be provided by general purpose display graphics at a greater cost than by using the actual servo- and synchro-driven instruments as recommended subsequently in Section VIII.

The experimenter's console monitor module allows the experimenter to examine and change various program parameters by means of his keyboard terminal or the switches on his console discussed in Section IX.

The data acquisition module embodied in the data acquisition computer will collect data not only from real-time running modules but also from the external measurement devices discussed in Section IX.

A recommended software organization will be described and specific requirements for various routines will be presented. Particular attention will be given to recommend modularity which will provide functional interchangeability among problems as the facility evolves. The user input to define each function will be recommended at the highest language level possible. This will allow simplicity in use without sacrificing flexibility by providing interchangeable modular versions of functions in Fig. 12 which require the fewest parametric descriptors.

Many of the following ideas are based on years of experience as experimenters on the sophisticated simulation facilities at the NASA Ames Research Center, particularly the Flight Simulator for Advanced Aircraft

(FSAA). Software features of that facility which we have found especially useful are incorporated herein. A comprehensive description of the software and hardware for the FSAA is given in Ref. 88.

The fundamental concept is to provide three basic computer modes similar to those of an analog computer: IC (Initial Condition), Hold, and Operate. Key features of each mode are as follows:

IC — Computer cycles through equations of motion but not in real time. Each cycle starts with an initialization routine to set initial conditions and for one time calculations. No integrations are performed.

Hold — Similar to IC but without initialization routine.

Operate — Computer cycles through equations of motion in real time. Integrations are performed.

Since the Operate mode is the only real-time mode and is therefore the most critical one with regard to the software organization, it will be discussed first and in more detail than the IC and Hold modes. The IC and Hold modes will be discussed subsequently.

2. Operate Mode

In the Operate mode the computer will be doing a repetitive numerical integration of the equations of motion and aircraft system operations as well as various I/O operations. A multiple loop organization is strongly recommended for this mode since a single loop operation where all routines cycle at the same rate has too many disadvantages. The principal disadvantages of a single loop are:

- A lack of flexibility in scheduling various computational and I/O functions
- A great reduction in the update rate on important vehicle states needed for the visual field and flight control system

The remainder of this section will assume that a two-loop structure is used. This is considered the minimum, and expansion to more loops is straightforward.

The equations of motion are separated into two parts, called LOOP1 and LOOP2, with LOOP1 having the shorter cycle time. A recommended partitioning of functions between LOOP1 and LOOP2 is outlined below:

LOOP1

- Higher-frequency control system functions
- Calculation of aerodynamic forces and moments
- Evaluation of winds and turbulence
- Integration of angular equations to get vehicle attitudes
- Integration of linear accelerations to get inertial velocities
- Computation of angles of attack and sideslip.

LOOP2

- Calculation of atmospheric properties and indicated airspeed
- Integration of linear velocities to get position
- Lower-frequency control system functions
- Calculation of propulsive system forces and moments
- Lower-frequency aerodynamic functions, e.g., update functional dependencies on Mach number and flap position
- Low-frequency facsimile aircraft system operations, including navigation, and guidance functions necessary for scenario generation.

While LOOP1 and LOOP2 provide for solving the equations of motion and aircraft system operations, several I/O functions must also be provided. The I/O functions are divided into five parts as described in Table 18.

TABLE 18
INPUT/OUTPUT (I/O) FUNCTIONS

Routine	Description	Typical Signals
ADC	Analog-to-digital conversion of signals from cockpit and experimenter's console	Longitudinal and lateral stick Rudder pedal Throttle lever Flap handle
DAC	Digital-to-analog conversion of signals to cockpit and experimenter's console	Cockpit instruments Strip chart recorders Control loading signals X-Y plotters
DIO	Discrete I/O to and from cockpit and experimenter's console	Mode controls Mode indications System controls System status indications Trim controls Event markers on strip chart recorders On/off control of strip chart recorders Stores controls Switches on experimenter's console to control discrete events
DD	Digital data to display graphics host computer	Aircraft attitude Waypoint bearing and range Head-up display parameters
DA	Digital data to data acquisition computer	Time Cockpit control deflections Performance metrics

These routines provide the communications between the host computer and the flight deck, experimenter's console, and other satellite computers. During IC and Hold modes communications will also be provided with the experimenter's console terminal. This will be discussed later.

Having considered the various functions to be performed in the Operate mode we turn next to discuss the schedule of these functions, i.e., to define the sequence in which they are to be accomplished. The software will provide great flexibility in the scheduling as the requirements can change dramatically from one problem to another. Two hypothetical examples of Operate mode schedules are shown in Fig. 13. They illustrate how the relative computation rates for the various routines might be changed to meet different problem requirements.

3. Real-Time Scheduling

Software to provide the real-time scheduling of the Operate mode routines can be quite complex, especially if the desired degree of flexibility is provided. Fortunately this capability is already provided in many real-time multiprogramming operating systems, such as the DEC RSX-11 series. We will assume that such an operating system is available to handle the scheduling. The remaining problem then is to organize the software to utilize this capability properly.

To retain the advantages of the RT-11 operating system's real time features, the following options are required with the RSX-11M operating system.

1. The acquisition of a real time clock, either in place of the standard clock* or as a peripheral device. (The software for using the clock is available from DEC.)
2. The use of the DEC-supplied, specialized I/O drivers in place of the standard I/O.

* The standard clock has a minimum time increment of only 1/60 sec.

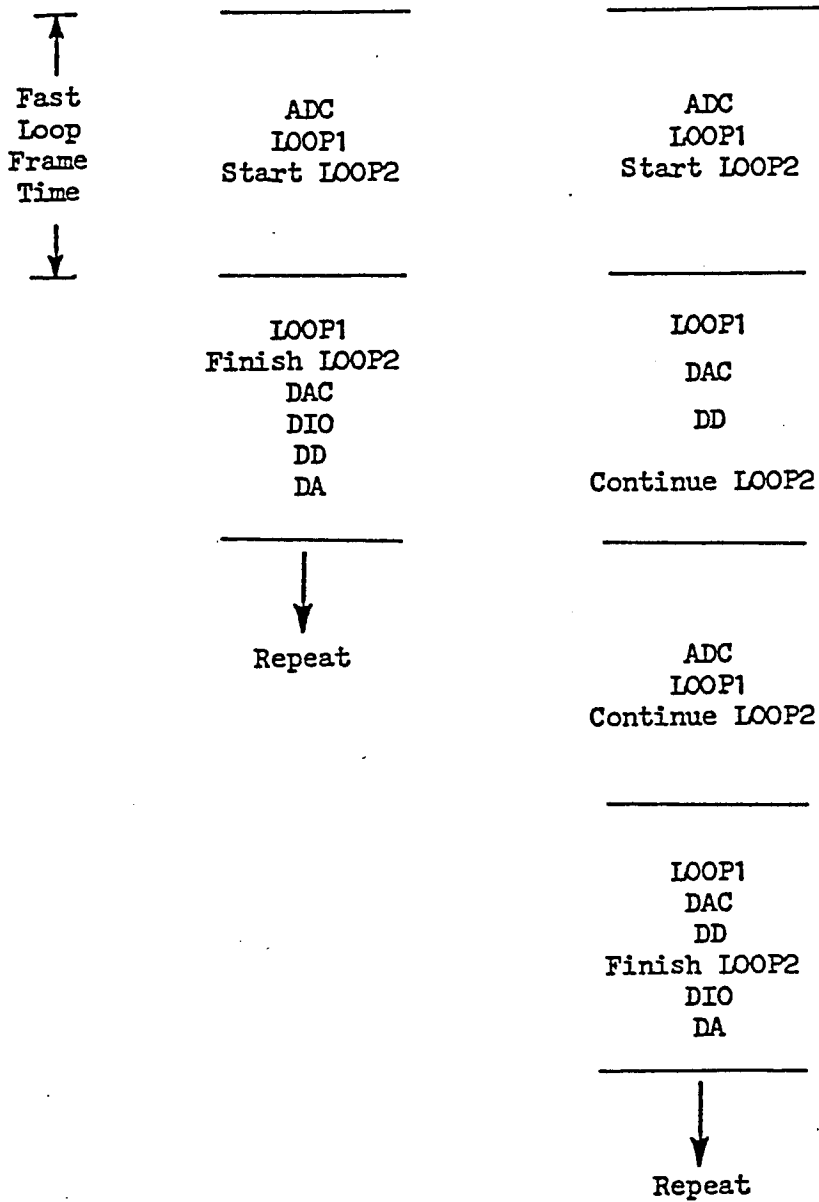

Figure 13. Examples of Operate Mode Scheduling

It should be noted that RT-11 was written for earlier and less powerful computers of the PDP-11 family, and that RSX-11M was written especially for the PDP-11/70. Thus RSX-11M provides the functions that were previously performed by RT-11 plus those that allow maximal use to be made of this much more powerful machine.

In using an operating system such as RSX-11M, the applications software is divided into tasks. Each task is a program which can run more or less independently but which can share or transfer data with other tasks. One task can activate or deactivate another task and establish a schedule or repetition rate for it. The repetition rates and priorities of various tasks determines the sequence in which they are executed.

The MAIN task would be in overall control. It would handle mode switching, setting up the Operate mode schedule through the operating system, and other functions discussed in the next subsection. The other tasks would be activated only in the Operate mode. They would be activated by the MAIN task which would also establish their repetition rates through a command to the operating system.

The other tasks would collectively represent all the Operate mode routines discussed earlier. In fact, by creating a separate task for each of the seven routines, (LOOP1, LOOP2, ADC, DAC, DIO, DID, DA) we can maintain a great deal of scheduling flexibility.

The only problem now is that most of the Operate mode calculations also must be performed in the IC and Hold modes. This can be overcome by simply having each of the tasks, other than MAIN, be merely a CALL to a corresponding subroutine, i.e., task LOOP1 only calls subroutine SLOOP1. This keeps all the computations in subroutines which can be called directly from MAIN when in IC or Hold mode. In these modes there is no real-time constraint, so MAIN can simply cycle through the subroutine calls repeatedly.

Using the same subroutines in all three modes avoids unnecessary duplication of software. However there are some computational differences among the modes. An obvious one is that integrations are performed only in the Operate mode. A less obvious one is the need to provide some

responses to the cockpit controls even in IC. After completing an experimental run, and the experimenter has returned to IC, the pilot may need to reset some controls for the next run, e.g., throttle and flaps. To avoid a large transient when going to Operate, at least the steady state responses to these controls must be generated. The engine thrust must go to the right value and the engine instruments must respond accordingly. The flaps must go to the desired angle and this must be reflected in the flap angle indicator.

Clearly each subroutine must contain whatever logic is required for each computer mode. Careful attention to this requirement must be exercised during the software development.

4. MAIN Task Description

The primary functions of this task are mode control and scheduling. Requests for mode changes would be initiated by switches or discrete keyboard commands in the cockpit and at the experimenter's console. These switches would be read during the discrete I/O.

The Operate mode has already been discussed. In IC, the MAIN task would cyclically call the following subroutines:

```
SETUP
SADC
SLOOP1
SLOOP2
SDAC
SDD
SDIO
```

The only new subroutine is SETUP. It performs certain initialization functions and one-time calculations. More details on SETUP are given subsequently in Subsection 6.

For the Hold mode, the same subroutine sequence can be used except for SETUP, which is not called.

The MAIN task has several important functions in addition to mode control and scheduling. These are discussed in the remainder of this subsection.

Normally the termination of an experimental run will be accomplished by switching from Operate back to IC at the experimenter's console. Before resuming the normal IC calculations, MAIN should take care of any end-of-run requirements. These might include special post-run calculations, data output, closing data files, strip chart calibration signals, and strip chart run numbers*.

Another function is error handling. These might be computational errors, e.g., overflow or square root of a negative number. Another type of error is the failure in Operate to complete calculations within the specified time interval.

The remaining functions to be described here all provide service in response to requests from the experimenter. In IC or Hold the computer will be cycling through a series of subroutines. This sequence can be interrupted by an experimenter's request from his keyboard terminal or the switches on his console. When the request has been serviced, the computer would return to the cyclic sequence.

One of the most important service functions is to allow the experimenter to examine and change various program parameters. This capability is vital during program debugging and very useful in controlling experimental variables. Among the parameters which should be accessible are:

- Initial conditions
- Wind and turbulence characteristics
- Ship or target characteristics
- Scheduling parameters

* Special signals can be used to "write" run numbers on the strip chart recorders.

- Data recording parameters
- Strip chart assignments, scale factors, and biases.

Simple and convenient access to any program variable is desirable but not easily accomplished. This is an important subject but too complex to discuss at this point. Subsection 5 describes three different approaches which might be used to provide this function.

While the terminal is a suitable medium for altering a few program parameters, the experimenter should also have a method for large scale changes. This can be accomplished by allowing the experimenter to specify a disk file which contains the desired changes. This would permit rapid (and error free) changes in the complete test scenario.

Another important function is the ability to trim the aircraft. To avoid large transients the aircraft must be trimmed before going to Operate. This can be accomplished by having the experimenter completely specify the initial conditions. A much more satisfactory approach is for the experimenter to specify only some initial conditions and to let the computer use the remainder to trim the aircraft. For example the experimenter might specify the aircraft initial position and velocity vectors, and the computer could adjust the aircraft attitude, thrust, and elevator deflection to trim it.

The trim routine is an iterative procedure. It varies selected parameters until equilibrium is established. It is desirable to have an algorithm that converges rapidly and is very general with regard to what combinations of initial conditions the experimenter specifies. For example, the experimenter may specify airspeed and rate of climb, or he could specify airspeed and throttle setting.

Such a general algorithm is very difficult to realize; therefore, careful consideration should be given to the required capabilities for the trim routine. It should be able to handle all reasonably likely situations but should not be overly general. It is better to have a few options that work reliably than a great many options which sometimes will not converge.

The trim routine also imposes requirements on subroutines SLOOP1 and SLOOP2. These subroutines will be used to determine the aircraft accelerations at each step of the trim iteration. Special logic is needed for trim just as it was for the various modes (IC, Hold, Operate). Integrations are not to be performed and provisions to bypass some control dynamics must be made. For example, one would have to bypass the engine and actuator dynamics to find the trim throttle and elevator settings.

The last MAIN task function we will discuss is to provide dynamic checks. This is strictly a debugging tool and is used principally to check the programmed aircraft and system dynamics. This routine would allow the experimenter to apply a prescribed input through one of the aircraft controls and observe (e.g., on the strip charts) the aircraft responses. The available inputs should include at least the primary cockpit controls: longitudinal and lateral stick, rudder, and throttle. Allowable wave forms should include step, pulse, doublet, and sine wave of specified magnitude and duration.

5. Accessing Program Parameters

As indicated in the previous subsection, the experimenter should be able to examine and change various program parameters. There are several methods of providing this capability, and three options are discussed below. They are discussed in the order of increasing programming effort required and increasing ease of use by the experimenter.

One method is to use the Debug routine which is part of the computer's operating system. This has great flexibility in that any program parameter can be accessed. The disadvantage is that most Debug routines require the user to specify the parameter address (memory location) rather than the FORTRAN name. This is clearly awkward for the experimenter and is likely to result in frequent mistakes. One is more apt to make a mistake in typing a number than a FORTRAN name. Furthermore a simple numerical error will probably still result in a valid address. An error in typing a FORTRAN name will probably produce an invalid name, and the computer can alert the user to that fact.

The second option is to write a FORTRAN (or assembly language) routine which provides access to selected program parameters. It would be quite simple to program if parameters were identified by a code number (use an EQUIVALENCE statement to select FORTRAN variables with an array). The program is only slightly more complex if the parameters are identified by their FORTRAN names or other mnemonics.

One disadvantage of this approach is that the routine will be specific to a particular program. Substantial changes may have to be made for each new program.

Another disadvantage is that the experimenter can access only selected parameters. It is very difficult to anticipate all the parameters one may wish to access. This is particularly true when debugging a program but also applies during the actual experimental tests.

The last option, and the best one from the experimenter's viewpoint, is to develop a routine comparable to CASPRE (Ref. 88). With the CASPRE routine one can access any parameter by its address or FORTRAN name. The CASPRE software uses the storage map generated by the compiler and the load map to determine the memory location of a specified FORTRAN name. This approach provides great flexibility and ease of use, but would require substantial software development. This option might be included in one of the later development phases of the facility.

6. Subroutine SETUP

This subroutine performs initialization functions and one-time calculations. Variables used as inputs to the real-time subroutines must be properly initialized, such as:

- Aircraft Euler angles
- Body axis angular rates
- Inertial velocity components
- Aircraft position.

There may be some initial condition options, e.g., specifying the initial speed in terms of Mach number, true airspeed, or equivalent airspeed. Logic to handle each of the options must be provided.

An example of a one-time calculation would be to compute the moments of inertia given an initial weight or configuration. This assumes that these would not be varied during the course of an experimental run.

7. Subroutine SLOOP1

This subroutine encompasses all the calculations which are to be done in the faster Operate loop. Many of these calculations, such as the kinematics, will be the same for all experiments. Others will be specific to a particular aircraft or experimental project. By partitioning SLOOP1 into several subroutines we can isolate the general and specific calculations, and also provide a functional breakdown.

The remainder of this subsection illustrates one method of partitioning. Several subroutines are described. Each is identified as a general subroutine or one that would be specific to a particular experiment. The functions and required outputs of each are indicated.

CONTR1 — Specific subroutine. Used for implementing the higher frequency components of the control system, such as stability augmentation and surface actuator dynamics. Outputs are control surface deflections.

AERO1 — Specific subroutine. Inputs are control surface deflections and aircraft state (e.g., airspeed, Mach number, dynamic pressure, angles of attack). Outputs are total aerodynamic forces and moments.

WIND — General subroutine. Models a deterministic wind as a function of position or time. Also models random turbulence with option for repeated or new turbulence on different runs. Outputs are the total velocity of the air mass and equivalent angular rates for gust gradient effects.

ROTATE — General subroutine. Integrates the rotational equations of motion and updates the Euler angles and body axis rates. Outputs are Euler angles, angular velocity, and body/earth transformation matrix.

LINEAR — General subroutine. Integrates the linear equations of motion and updates inertial velocity. Outputs are inertial velocity components.

AIRSPD — General subroutine. Computes aircraft velocity relative to air mass. Outputs are airspeed, angle of attack, and angle of sideslip.

DATA — Specific subroutine. Used for real-time data collection and processing. Will supply data from real-time running modules to satellite data acquisition computer.

INSTR1 — General subroutine. Used to compute drive signals for some cockpit instruments, e.g., to compensate for instrument non-linearities. Outputs are drive signals for instruments.

DISPLAY — Specific subroutine. Computes any special quantities required for the visual field and display graphics computers.

8. Subroutine SLOOP2

This subroutine encompasses all the calculations which are to be done in the slower Operate loop. These should also be partitioned into various subroutines. One method of partitioning is illustrated below.

ATMOSPH — General subroutine. Computes atmospheric properties as function of altitude and other aerodynamic quantities. Outputs are atmospheric density, pressure, dynamic pressure, Mach number, equivalent airspeed, and calibrated airspeed.

POSIT — General subroutine. Integrates linear velocity to get aircraft position.

CONTR2 — Specific subroutine. Used for implementing the lower frequency components of the control system, e.g., flaps, trim system, and guidance loops.

ENGINE — Specific subroutine. Models the propulsion system. Outputs are total propulsive forces and moments, and variables needed to drive cockpit engine instruments.

AERO2 — Specific subroutine. Used for implementing the lower frequency components of the aerodynamic model, e.g., updating coefficients or tables used in AERO1 which are functions of flap or Mach number.

INSTR2 — General subroutine. Used to implement a variety of lower frequency functions for the cockpit instruments and other output devices. Provides compensation to drive non-linear instruments. Turns strip chart recorders on and off and controls paper speed. Provides special signals for strip chart recorders, such as: variable sensitivity as a function of range or altitude; variable bias, e.g., "cyclic" display which jumps to opposite edge when pen reaches one edge limit; multiplexing of two variables on one recorder channel.

SCENE — Specific subroutine. Used in conjunction with POSIT, DISPLAY, and CONTR2 for implementing the low frequency facsimile outputs from aircraft system operations, including navigation and guidance functions necessary for scenario generation. Provides relative positions of runway, navaid, waypoint for DISPLAY, and calculates guidance commands for CONTR2.

This concludes a preview of the computer software required for the facility. In the next section we shall outline some of the requirements for the flight crew stations.

SECTION VIII

FLIGHT CREW STATIONS

The flight decks for the MVSRF will provide operating facsimiles of control-display crew stations for pilot, copilot, and flight engineer who will participate in the evaluations of the causes of human error. In addition a seat and space for an observer will be provided on each flight deck aft of the pilot with a clear view of the three operating crew members. Four adjustable flight-qualified seats will be provided on each flight deck. Whereas it is important that the crew station layout help to induce the correct forms of the crew member's cognitive and psychomotor behavior, it is not necessary that each crew station be an exact replica of that in a specific aircraft. Nevertheless, as we stated at the outset in Section I, the identical elements theory of Thorndike will likely be invoked for the current technology flight deck. Thus it would seem to be cost-effective to provide the current technology flight deck by adapting the same from a training simulator for the chosen aircraft as recommended in Ref. 5. This is because of the importance (for studying the causes of human error) which is vested in the capability for initiating, monitoring, and controlling various flight and ATC system malfunctions and failures in the MVSRF. Reverse transfer of training (from flight experience to the MVSRF) is thus very important among flight crew members who will participate in full mission simulations. Reverse transfer is believed to be assured by providing a current technology flight deck which is functionally identical to that in a contemporary jet transport with which a significant portion of the airline pilot population has experience.

Likewise, because of the importance attached to studying the causes of human error, access to "initial condition," "hold," or "reset" control over the simulation should not be provided within the flight deck, thereby denying to the crew one means for concealing human error in the simulator.

Both crew station designs should, however, provide for relatively convenient access to the display and control installations for modification and maintenance and should be open and spacious enough so that

portable measuring equipment can be easily installed without interference in each operator's activities. Each flight deck itself will be mounted on a fixed base with provision for subsequent addition of a motion base. Convenient access for ingress and egress is also recommended, yet each crew station should provide an opaque enclosure for excluding ambient illumination while admitting a flow of conditioned air for crew member comfort.

Some requirements for the crew stations in the advanced technology flight deck are summarized next. The functional layout of the pilot's and copilot's controls and displays will be as consistent as possible with the corresponding two-abreast crew stations in transport aircraft expected to be operational in the time period of interest. The flight engineer's station in the advanced technology cockpit will be aft of the central console between pilot and copilot, but facing the central console. The observer will be aft of the pilot. The flight deck will consist of a structural frame and shell, removable opaque windows and windscreen with provisions for pilot's and copilot's collimated external visual displays, aft door for ingress/egress, adjustable flight qualified seats, pilot's and copilot's two-axis pedestal controllers with trim controls and variable loading, pilot's and copilot's adjustable rudder pedals, common throttle controls on the central console, direct lift or thrust vector controls, also on the central console, programmable time-shared control display units for aircraft systems, lighting and air conditioning and their respective controls, fuel and energy management controls, automatic flight controls, CNI* controls, data cases, audio intercommunication set and its controls, necessary cabling to interconnect with the facility input/output subsystem, provision for crew performance monitoring equipment, and audio environmental special effects. We shall now discuss and recommend the following items required for the advanced technology crew stations, viz.,

* Communication, Navigation, and Identification.

- External visual field and head-up displays
- Primary head-down displays (e.g., VSD, HSD, MPD, SAD)
- Display graphics generator
- Controls and control loading
- Flight instruments
- Programmable multifunction keyboard.

A. EXTERNAL VISUAL FIELD AND HEAD-UP DISPLAYS

The requirements and equipmental candidates, including the cathode ray tubes, for presenting the collimated visual-field and head-up display are presented and discussed in the foregoing Section III.

On the flight deck each display will consist of two cathode ray tubes with their optical collimators, one mounted in place of the pilot's windscreen, the other in place of the copilot's windscreen. Each display will initially provide a 45-deg-azimuth by 35-deg-elevation field of view and properly scaled virtual image approaching optical infinity. Future visual traffic detection and STOL investigations may require additional field of view, e.g., side window views for curved approaches. For this reason the external visual display must be modular so that it can be expanded to provide more field of view (Ref. 3).

B. PRIMARY HEAD-DOWN DISPLAYS

The control-display configuration of the advanced technology crew station will include at least the following primary head-down display functions and equipment on the instrument panel in the pilot's, copilot's, and flight engineer's forward fields of view.

1. Vertical Situation Display (VSD)

The VSD will be capable of displaying computer-generated alphanumeric, calligraphic, and raster-graphic data having the format of an electronic

attitude director indicator. The VSD will also be capable of presenting a simulated processed forward-looking sensor (such as radar, TV, IR) information consistent with the pilot's view of the external world in azimuth and elevation. Flight command, navigation, and discrete information may be superimposed on the VSD. Adjustable brightness and contrast controls for the VSD should be located conveniently on the display. Two VSDs are required, one in front of the pilot, the other in front of the copilot.

2. Horizontal Situation Display (HSD)

The HSD will be capable of displaying computer-generated alphanumeric, calligraphic, and raster-graphic data having the format of an electronic moving map. The HSD will also be capable of presenting a simulated processed sensor (such as radar, TV, IR) information consistent with the pilot's "plan view" of the external world with respect to the nadir. Computer-generated navigational and traffic information may be superimposed on the HSD, and the HSD will serve as a backup display for the VSD. Adjustable brightness and contrast controls for the HSD should be located conveniently on the display. Two HSDs are required, one below the VSD in front of the pilot, the other likewise in front of the copilot.

3. Multipurpose Display (MPD)

The MPD will be capable of displaying computer-generated alphanumeric, calligraphic, and raster graphic data having formats appropriate for aircraft propulsion, data link communications, and other on-board systems monitors. The MPD will be used for systems operation and fault diagnosis by the flight engineer as well as the other crew members. Adjustable brightness and contrast controls for the MPD should be located conveniently on the display as well as on the flight engineer's console. Two MPDs are required right and left of the center of the instrument panel.

4. Status Advisory Display (SAD)

The SAD will be capable of displaying computer-generated alphanumeric, calligraphic, and raster-graphic data having the formats of engine status, warning, caution, subsystem mode, and auxiliary subsystem management displays. One SAD should be centrally located for viewing by all crew members and should have adjustable brightness and contrast controls located conveniently on the display as well as on the flight engineer's console. At least two other SADs should be located outboard of the pilot's and copilot's VSDs.

5. Flight Instruments

Provision should be made for the inclusion of conventional back-up instruments such as artificial horizon or ADI, turn-and-bank, airspeed, ground speed, course, heading or HSI, instantaneous vertical speed, barometric and radio altitude instruments, and a clock with controllable elapsed time indication function on the pilot's instrument panel.

C. DISPLAY GRAPHICS GENERATOR

The display graphics generator is used in conjunction with the "host" digital computer to generate a variety of display formats for projection on the CRT displays of the advanced technology flight deck and experimenter's console. The CRT display formats will be representative of those formats generated in the display programs of advanced systems such as the terminal configured vehicle (e.g., EADI, EHSDI, FMS, CDTI, ACARS, ATIS, DABS, and BCAS in Ref. 96).

A number of commercial graphics generator systems are available today. Three techniques for writing the CRT picture are in use. These techniques employ random-vector or stroke writing (calligraphy), the

raster, and the storage tube* (Ref. 97). However calligraphic and raster graphic techniques dominate the commercial market for computer graphics. The image on a non-storage CRT needs to be refreshed to hold the image and avoid flickering. Storage tubes can store an image for considerable time without refreshing. Random vector systems draw images as line segments from point to point. Raster systems use horizontal and vertical sweeps as in a TV, brightening the sweep at desired points to form the image. The raster system can mix real-time video and computer-generated video; however, raster mixing update rates will not be as great as with the scan conversion storage tube.

Capability of the display graphics generator to generate electronically geometric symbols and alphanumerics is essential. Both calligraphic and raster systems described in Table 11 (in Section III) offer the combined capability to program geometrics and alphanumerics; however, the raster technique offers a more efficient way than calligraphic to generate alphanumerics.

The choice of display graphics generator technique and equipment selection will be dictated by data display requirements, computer software support by the manufacturer, and cost. A calligraphic chromatic generator is recommended initially, primarily because it will provide better resolution at reasonable cost for the head-down vertical situation display (VSD), which may have elements in common with the HUD. Eventually separate calligraphic and raster display graphics generators appear to be

* Two types of storage tube are used today, the direct view type and the scan converter. The latter is the most ideal candidate for the graphics application but is not predominantly available commercially for computer graphics generation. The scan converter combines techniques of the random, raster, and storage types. The image is written in random technique on an internal storage tube and the information is then transferred to a standard TV (raster) monitor for display.

Scan conversion offers the potential advantage of lower price over refresh systems, it can be selectively erased, and it can mix real-time video and computer-generated graphics. Complex visual scenes are still subject to update rate limitations with the scan converter, but for most of the graphics displays complex visual scenes are not required.

necessary since no vendors offer a combination at this time or for the foreseeable future, and the horizontal situation displays (HSD), multi-purpose displays (MPD), and status advisory displays (SAD) could make more efficient use of a raster graphic generator. Although one graphics computer may be sufficient initially, two graphics computers are recommended eventually to avoid update rate limitations (via direct memory access) in presenting both calligraphics and raster graphics. Since different phosphors are required in the cathode ray tubes for the calligraphic or raster presentations, interchangeable cathode ray tubes may be needed in the multipurpose display, for example.

D. CONTROLS AND CONTROL LOADING

At the outset it will be sufficient to provide only fixed mechanical spring force gradients on each of the advanced technology primary flight controls. However a modular programmable control loading system is ultimately recommended for primary flight controls, even in the advanced technology flight deck.

While it is recognized that the facility is not intended for simulation studies of control feel characteristics, it is believed that a low fidelity representation of these characteristics would prove distracting to pilot subjects to the level where it might degrade their responses in evaluating and acting on the information portrayed on their displays. Therefore it is desirable to invest in a modular control-and-loading installation which will provide electro-mechanical adjustable force feel as a function of the represented aircraft flight condition. Examples of such modular control loading equipment are described in Appendix C.

E. FLIGHT INSTRUMENTS

The problem of presenting cockpit flight instruments is most easily solved by using actual aircraft instruments driven by DC-to-synchro converters. The one exception to this would be the altimeter.

Synchro-driven cockpit instruments can be adapted for MVSRF with the aid of an item of equipment provided, for example, by McFadden Electronics Company, in addition to the necessary accompanying channels of digital-to-analog (D/A) signal conversion which are planned for the facility.

The universal McFadden Model 205A1 Instrument Servo Assembly is a DC-to-synchro converter which functions as an interface between analog voltages and flight-qualified synchro driven cockpit flight instruments. The system is designed on a modular basis — five channel modules with integral power supply per system — to enable future expansion with maximum ease. It has gained wide acceptance among users of flight simulators. Each channel is a complete closed loop servo which accepts DC signals from an analog computer or D/A converters and provides synchro transmitter output proportional to command voltage. With a 5- or 10-channel system, any 5 or 10 synchro driven aircraft instruments can easily be converted to DC servo-driven instruments. This system provides smooth motion and fast, first order response.

By adding another synchro to each module provision can be made to drive a second instrument (at the experimenter's console) if it be desired to duplicate the pilot's display. A 26 VAC 400 Hz reference supply is also required. Specifications for Model 205A1 DC Instrument Servo Assembly are given in Table 20 together with a photograph.

The McFadden Model 106B DC Servo Altimeter is a high-performance, multiturn, closed-loop position servo which drives directly the hands of a conventional altimeter with a range from 0 to 100,000 ft and a lighted dial. The normal barometric sensor has been removed and the case has been elongated to accommodate the servo components. It provides smooth motion over a wide dynamic range, low threshold, fast stable response, and low resolution and is available in 10V or 100V scaling. Specifications and a photograph are provided in Table 20.

F. PROGRAMMABLE MULTIFUNCTION KEYBOARD

Discrete function, mode, and status controls at the crew stations in the facility are best provided by a flexible easy-to-use controller which

TABLE 19

SPECIFICATIONS FOR McFADDEN COCKPIT SIMULATOR INSTRUMENTS

COCKPIT SIMULATOR INSTRUMENTS



MODEL 206B DC SIMULATOR ALTIMETER

The Model 206B DC Simulator Altimeter is a high performance multi-turn, closed loop position servo which direct drives the hands of a conventional cockpit altimeter. The normal barometric sensor has been removed and the case has been elongated to accommodate the servo components. Standard panel mounting is retained. The Model 206B features smooth motion over a wide dynamic range, low threshold, fast stable response and low resolution. Available with 10V or 100V scaling.

SPECIFICATIONS:

Range: 0 to 100,000 ft
 Input: -10V to +10V (0.2V/1000 ft) or
 -100V to +100V (2V/1000 ft)
 Impedance: Greater than 20K
 Accuracy: +0.33% of altitude or 50 ft
 (whichever is greater)
 Resolution: Less than 10 ft
 Power: +15V DC, 0.2A, 0.1% Reg
 Max Rate: Greater than 200,000 ft/min

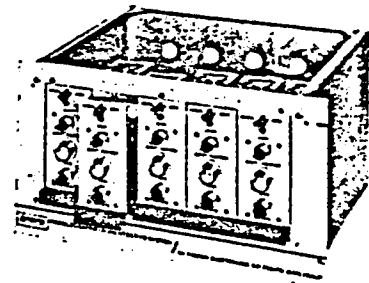

MODEL 205A1 DC INSTRUMENT SERVO

The Model 205A1 Instrument Servo Assembly is a complete closed-loop device which accepts D.C. signals from an analog computer or other source and provides an output shaft position proportional to command voltage, i.e. DC to synchro converter. The unit is designed around 5 channel modules with an integral power supply. The system is designed on a modular basis to enable future expansion with maximum ease. One application is DC to Synchro interfacing between Computer and Cockpit Simulator Instruments. Features include smooth motion and fast, first order response.

SPECIFICATIONS:

Input: Voltage: +10V or +100V F.S.
 Impedance: 30K Ω scaling pot
 Output: Mechanical: 1,2,3,5,10 or 20 turns F.S.
 Electrical: 5 leads from synchro transmitter
 Accuracy: +0.2% of F.S.
 measured at the feedback pot
 Resolution: Less than 0.02% of F.S.
 Minimum Smooth Rate: Less than 0.02% of F.S. per sec
 Slewing Rate: Greater than 25% of F.S.

is not aircraft console-specific and which is compatible with the EAI Standard RS-232C digital interface. An example of such a controller is available from Instrumentation Technology Corporation (ITC), Northridge, California as Model 9654 Plasma Display Terminal. It looks like (and can be used as) a teletype to a computer system, but it can also be used as a programmable multifunction keyboard. The man-machine interface is accomplished by means of a programmable graphic display with built-in operator touch control.

The heart of the system is a Digital Equipment Corporation LSI-11 microcomputer, which is software-compatible with the PDP-11 family of minicomputers. The availability of extensive LSI-11 software makes the Model 9654 well suited to be used also as a stand-alone computing tool. A functional description and technical specification are provided in Appendix D.

SECTION IX

EXPERIMENTER'S CONSOLE AND DATA ACQUISITION SYSTEM

The purposes of each experimenter's station (Fig. 1, Section I) are fourfold:

- Control the overall operation of the facility; hence the alternative names: facility operator's console or operator's station.
- Permit the setup, checkout, control, and monitoring of the experimental scenario including air-traffic control, mission-related tasks and subsidiary workload measurement tasks discussed in Ref. 2.
- Allow the setup, checkout, control, and monitoring of flight crew procedure, measures of system performance, and subject behavior.
- Provide for non-intrusive on-line and archive data acquisition.

The hardware and software operator interfaces should be based on sound human factors principles. Each experimenter's station should allow for convenient and reliable manipulation of the experimental conditions and scenario, and give the operator a "bird's eye" view of facility status and subject performance. Each experimenter's station should permit either independent or coordinated operation of both current and advanced technology simulations with or without simulated air traffic control authority. In the next topic we shall consider the current technology simulation console in more detail.

A. CURRENT TECHNOLOGY SIMULATION CONSOLE

Preliminary functional requirements for the experimenter's console in the current technology simulation were outlined in Section I. The experimenter's console functions can be briefly summarized as follows:

Flight and crew performance monitoring
Traffic controller performance monitoring
Crew comfort monitoring
Malfunction control over the vehicle and flight system models
Data acquisition control
Operational control of the simulation
Communication control
Environmental control.

Except for the more comprehensive performance monitoring, data acquisition, and operational control functions needed in the MVSRF, virtually all of the basic functional requirements are provided in the operator's console of a current technology aircraft training simulator. Thus, as in the case of the current technology flight deck, it is also cost-effective to provide the current technology experimenter's console by adapting and expanding the instructor's station from a training simulator for the chosen aircraft. To the instructor's console should be added the performance monitoring, data acquisition, and operational control functions needed for the MVSRF. The performance monitoring and data acquisition functions should include measurements described in Ref. 2 which are suitable for:

Procedure-centered evaluation
System performance-centered evaluation
Human operator-centered evaluation.

The data acquisition media should include

On-line display
Soft copy (e.g., magnetic tape)
Hard copy (e.g., strip charts, printed paper)

To the operational controls should be added an interactive graphics and text display terminal with keyboard and hard copy printer to aid both operator and experimenter in effecting necessary modifications to the software described in Section VII.

The suggested layout of the operator's station and data acquisition functions should also take into account current laboratory equipment and capabilities available to the Man-Vehicle Systems Branch as well as recommended future equipment, capabilities, and computer program development. The current equipment and capabilities which we recommend to be tied in with the operator's station are as follows:

- Oculometer and associated equipment. The oculometer sensor will be mounted in the instrument panel and the associated signal processor and teletype will be located at the experimenter's station. The two eye-point-of-regard output signals can be connected with the data acquisition system via its A/D converters for further processing with a currently available program (e.g., Ref. 98).
- Semi-Portable Physiological System (optional). The purpose of this unit is to provide measures of workload-induced stress. In order to minimize obtrusiveness in the cockpit and to ensure the greatest possible realism, physiological measures will be omitted initially (Ref. 7). In the event that these measures are added, this unit should be mounted adjacent to the experimenters' station with provision for sending available electrical analog signals such as electrocardiograph (EKG), electroencephalograph (EEG), electromyograph (EMG), respiration rate, and Palmar skin resistance to the data acquisition system via its A/D converters, discussed hereafter. On-line monitoring can be provided by the unit's own chart recorder.
- Voice Stress Analysis System. This system can also be used to provide a measure of workload-induced stress. The audio tape recorder furnished with this device should be tied in with the facility communication system, discussed hereafter. Tape recordings would then be used for voice analysis offline and the stress evaluator would not have to be located within the experimenter's station.

It is further recommended that the experimenter's station capabilities be expanded to include the following functions.

- Data acquisition computer system and associated peripherals. The block diagram in Fig. 14 illustrates the recommended duplex signal routing for acquiring and monitoring experimental data in real time using the data acquisition system. For this purpose, the data acquisition system should also be connected via a new digital interface with each host computer having executive control of the experiment. For the current technology flight deck, 16 channels of A/D and 16 channels of D/A conversion should be acquired initially for routing data to analog displays on the experimenters' console and to strip chart recorders. A CRT/keyboard terminal and line printer can also be used for data display and magnetic tape units can be used for storage of monitored data. With the addition of the advanced technology flight deck, we also recommend the addition of 16 channels of A/D and 16 channels of D/A conversion interface for on-line monitoring of crew comfort and performance.
- Communications Controls. An example of a multiple-station communications control panel for the experimenter's console is shown in Fig. 15, based on Ref. 99. The controls on this panel enable the facility operator and experimenter to communicate by voice with all participants in the flight and traffic control simulation. By use of the push-button switches, symbolically represented in Fig. 15 by squares (□), the operator may establish several point-to-point links or conference networks for either one-way or two-way communication as desired. The operator and experimenter may monitor the voice link or speak over it. Controls for the recording bus and noise sources are also available on the panel.

In the next topic we shall consider the advanced technology simulation console in more detail.

B. ADVANCED TECHNOLOGY SIMULATION CONSOLE

The operator's control console for the advanced technology simulation should likewise be designed to enable the experimenter to control and monitor the progress of the simulation and the comfort status of the crew members. A suggested layout of the experimenter's console is shown in Fig. 16. The following functions are recommended.

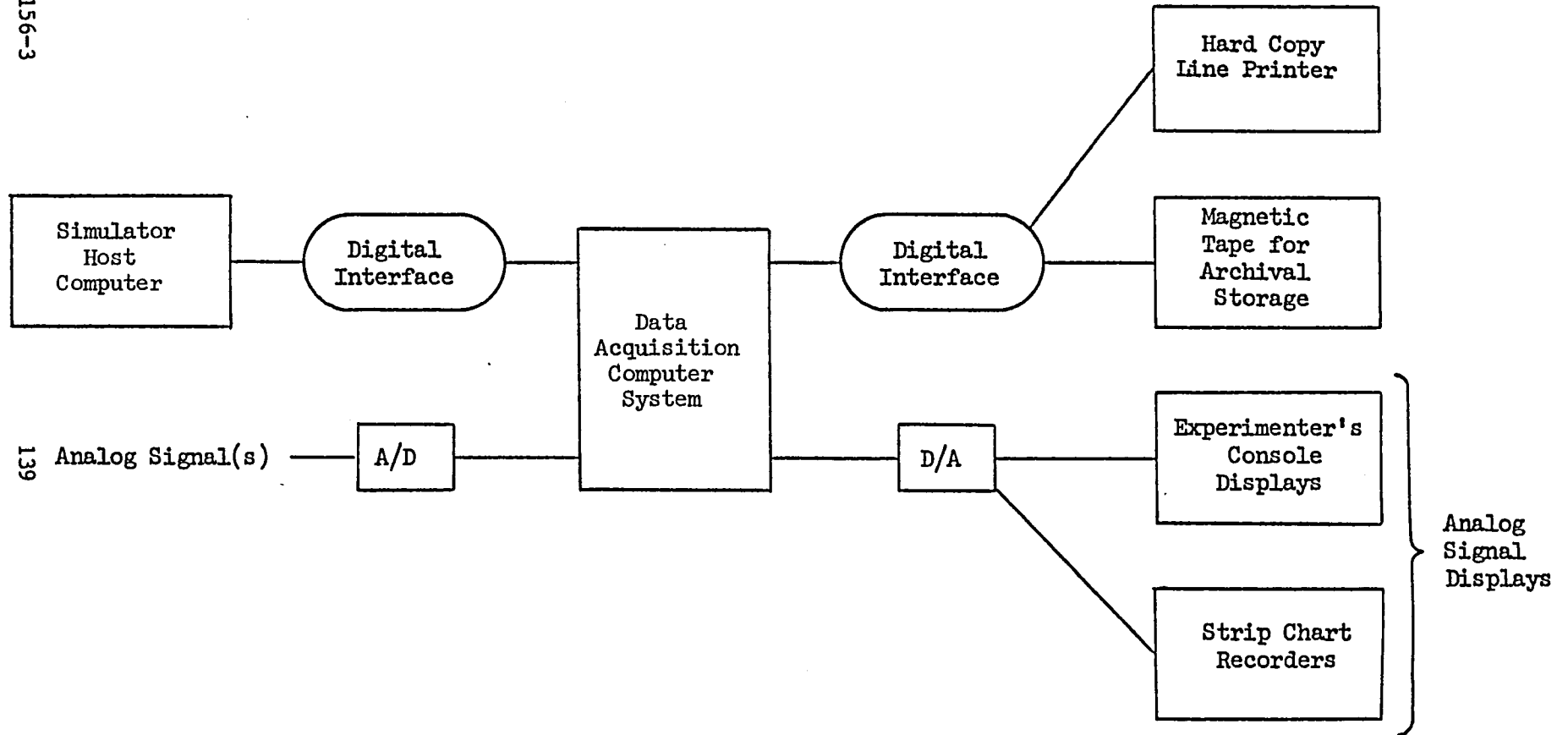

Figure 14. Recommended Duplex Signal Routing for Acquiring and Monitoring Experimental Data

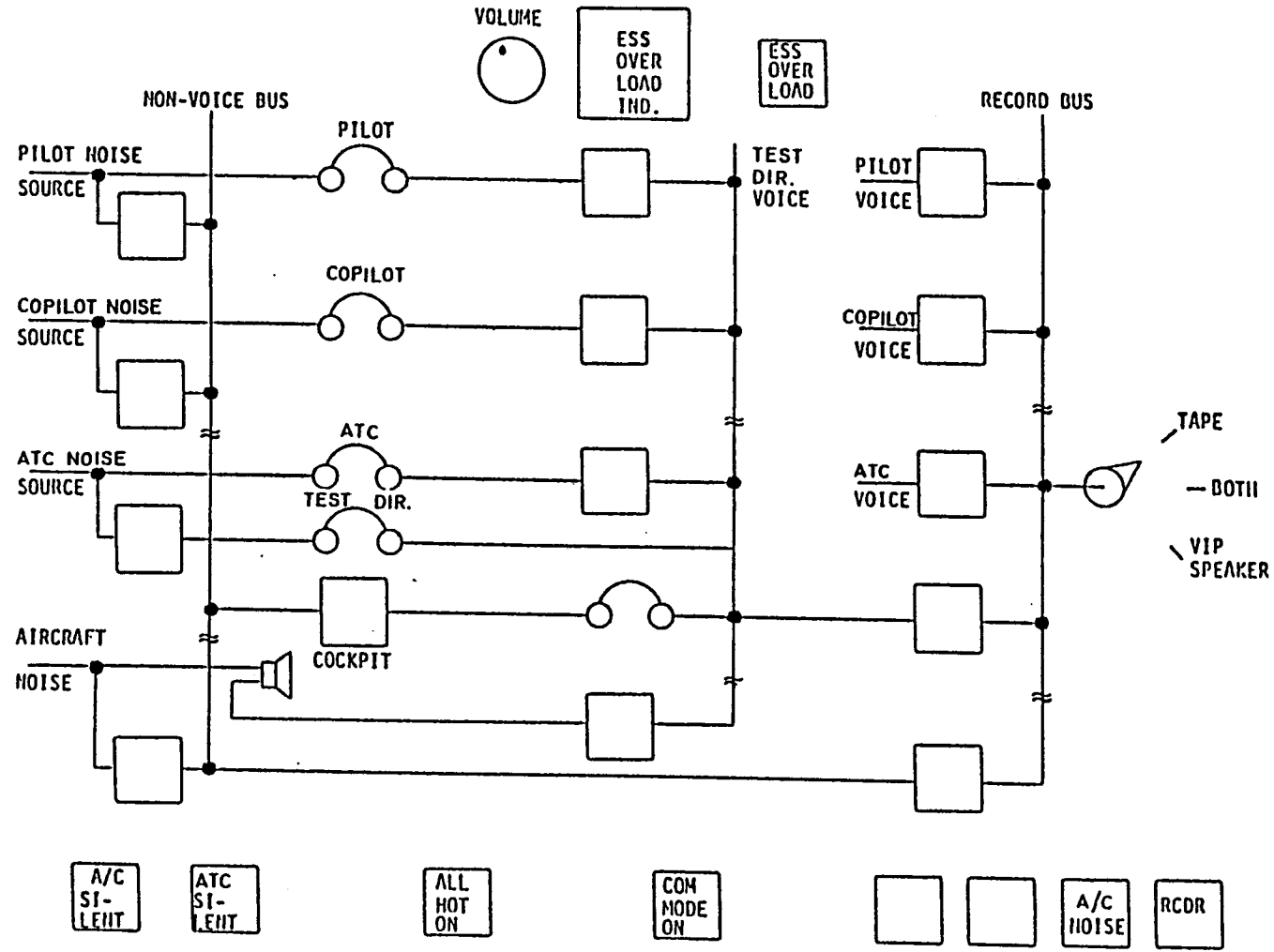

Figure 15. Example of Facility Operator's Communications Panel
(Based on Ref. 99)

1. **Head-Up Display and Visual Field Display Monitor;
Vertical Situation Display Monitor; and
Horizontal Situation Display Monitor**

The central region of the experimenter's console in Fig. 16 is reserved for two 21-inch CRT monitors. One of the 21-inch monitors will repeat the combined head-up display-and-visual field and the other, a split screen arrangement of the VSD and the HSD as seen in the cockpit. Each monitor display should be shielded (e.g., by hood or filter) from ambient incident illumination and should be provided with independent brightness and contrast controls.

2. **Multipurpose Display Monitors and
Status Advisory Display Monitors**

Monitors are recommended left and right of center in Fig. 16 for multipurpose and status advisory displays, all of which are likely to be in raster format.

3. **Backup Flight Instruments (Optional)**

Backup flight instrument repeaters, located at the upper left in Fig. 16, are recommended with provision for glare shielding and independently controlled lighting.

4. **Simulator Status Displays and
Interactive Controls**

Simulator status displays [e.g., host computer(s), graphic generator(s), control loading, data acquisition] and interactive controls are recommended. Real time operating controls for problem setup, operation, options, hold, and reset or initial condition are shown left of center at the bottom of the console. Host terminal controls (extreme lower left) should be provided for changing, while a problem is in progress, initial conditions, constants, and data acquisition. It should also be possible, while a problem is in progress, to delete and restore primary display

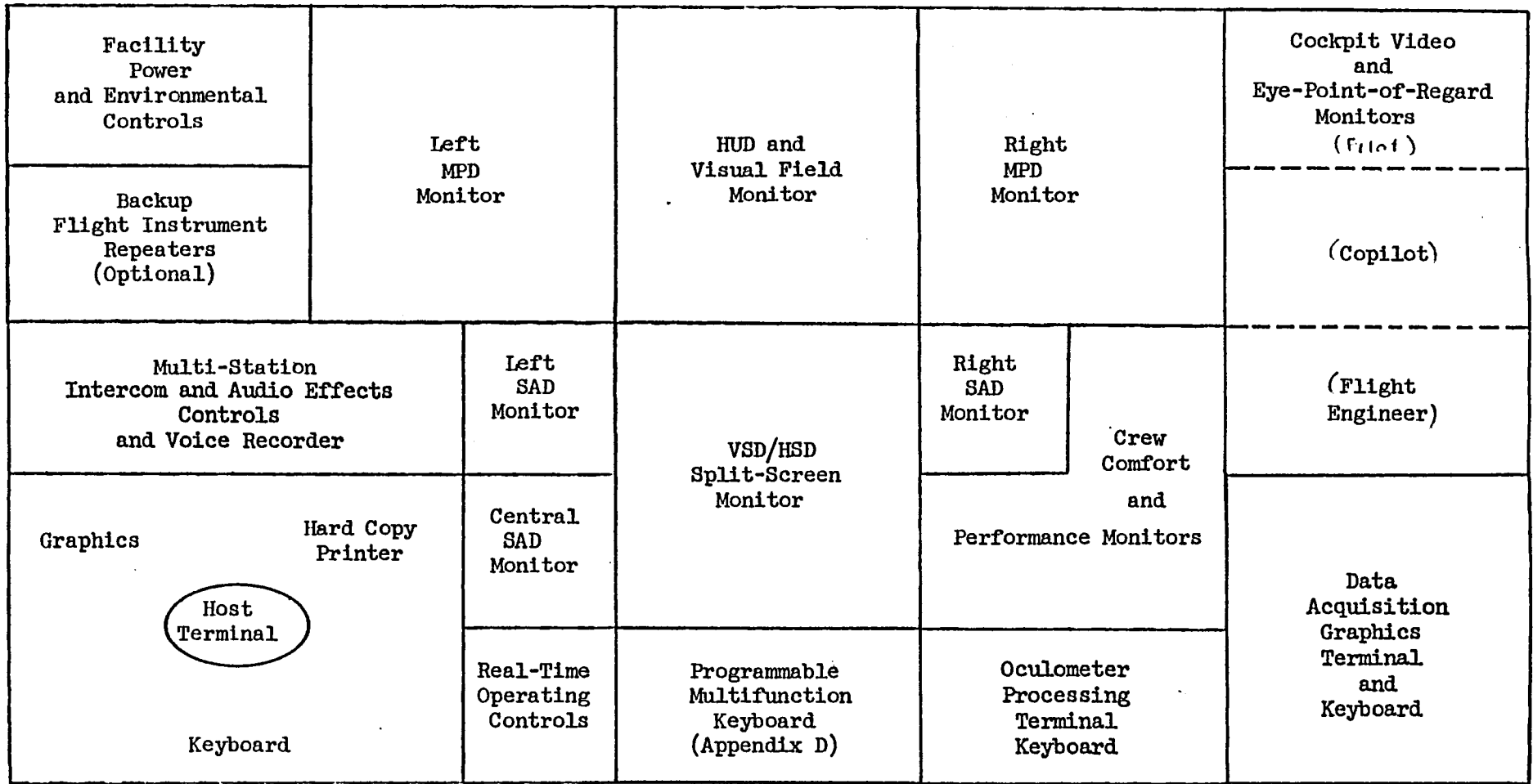

Figure 16. Recommended Experimental Operators' Console Layout For Advanced Technology Simulation

symbols which are within the programmed repertory for the HUD, VSD, HSD, MPD, and/or SAD. Positive means should be provided via graphics display for confirming, while a problem is in progress, that all required data are being recorded or stored.

The operator's graphics terminal and control keyboard is shown at the lower left of the console layout in Fig. 16 beside the real-time operating controls. This terminal will communicate with the host computer having executive control of the experiment. Provision is shown for an on-line interactive graphics display terminal with keyboard and built-in hard-copy printer, which provides for graphic waveform analysis as well as inspection of text. This terminal can also be used to transfer mission variables from the host computer to the data acquisition system for subsequent display on the graphics terminal shown on the lower right side of the console in Fig. 16. An added feature of this last approach is that the mission variables being monitored are then available for archival tape recording and/or processing by the data acquisition system, the control keyboard for which is also located in the extreme lower right corner of the console, Fig. 16.

A programmable multifunction keyboard (viz., keyset) is also recommended for inclusion in the lower center of the experimenter's console in Fig. 16. Such a keyset is described in Appendix D and can be used more easily by the experimenter to set up conditions and configurations with single keystrokes as opposed to the formatted, multi-character instructions required from the standard host keyboard terminal. The keyset would operate through a standard serial (RS-232C) digital interface to the host computer. Keyset inputs could be used to call up menus on the CRT interface, then further keyset inputs would be used to select conditions listed in the menu. These latter commands would call subroutines which would communicate with the experimental control software to set up specific experimental configurations. An experiment would then be initiated in response to further keyset commands.

5. Comfort Status Displays (e.g., Cockpit Temperature) and Crew Performance Monitor Displays and Controls

Crew "comfort and performance" monitors are shown at the right of center on the console in Fig. 16. These monitor panels would consist of circular or strip chart recorders and designed to monitor, for example, the variety of on-line performance and workload measures suggested in Ref. 2 and Fig. 17. Crew comfort monitors, for example, would display cockpit temperature and relative humidity as well as the selected psychophysiological variables suggested in Fig. 17. Crew comfort and performance data should be displayed at the operator's console to allow for monitoring the progression of data as it is acquired in real time rather than post hoc.

Another means of on-line monitoring of crew performance will be to provide eye-point-of-regard superimposed on display video. One approach will be to use closed circuit TV to monitor the pilot's display panel. Three cockpit video monitors for this purpose are shown at the extreme upper right of the experimental operator's console in Fig. 17. The two eye-point-of-regard signals for each crew member are connected to a console monitor from the data acquisition system via D/A converters to permit duplex on-line eye scanning monitoring in addition to the preliminary statistical analysis which is possible with currently available software (e.g., Ref. 98). Each pair of eye-point-of-regard signals is also applied to its corresponding monitor shown at the upper right of the console in Fig. 16. The CRT monitor serves as a flying spot scanner with the display video overlay showing relative location of the cockpit displays in the pilot's field of view. The flying spot on the CRT denotes the pilot's eye point of regard. The oculometer processing terminal keyboard is located right of center at the bottom of the console next to the data acquisition graphics terminal and keyboard.

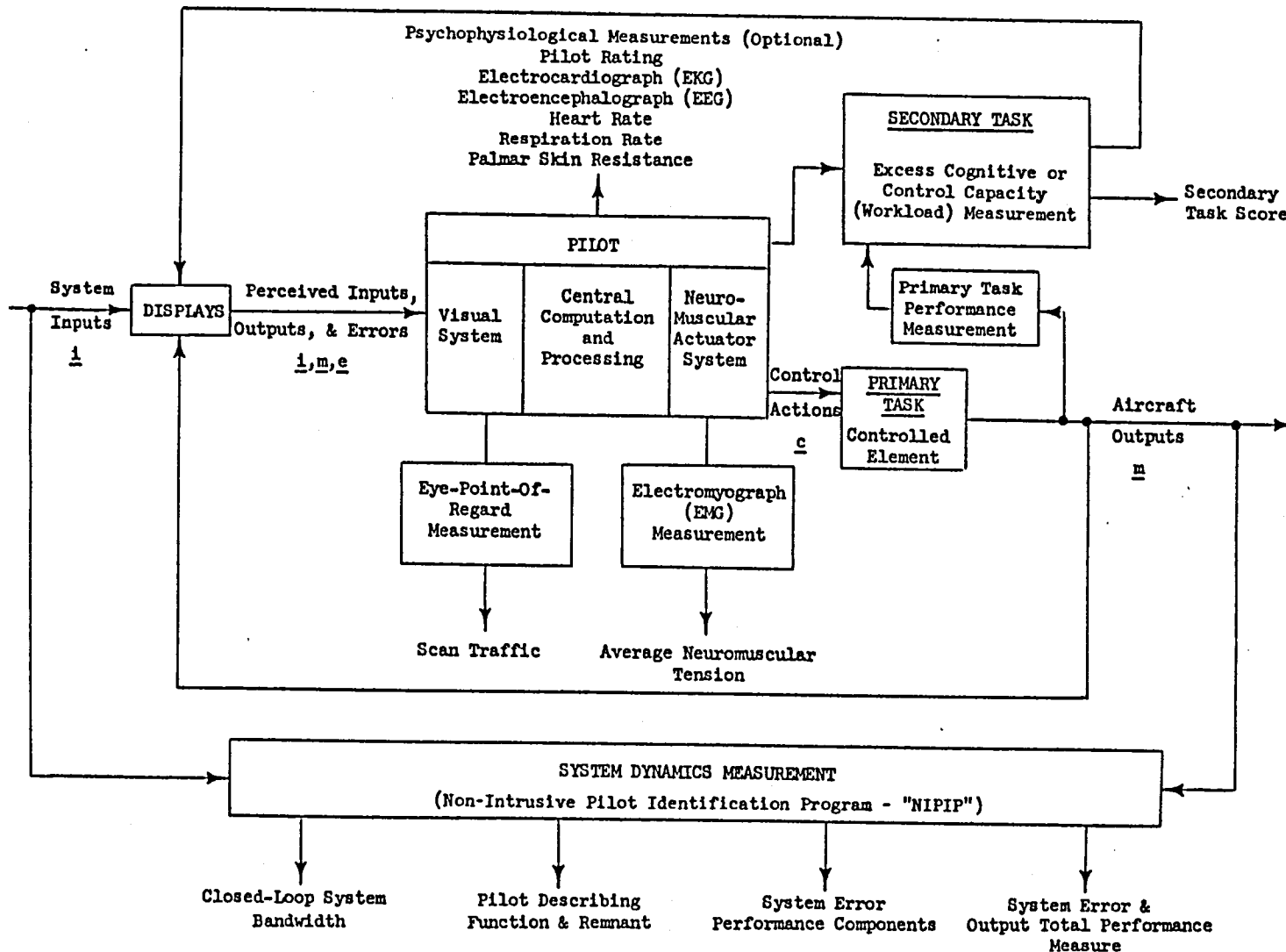

Figure 17. System and Pilot Dynamic Response, Cognitive or Control Capacity, and Scanning Workload Measurements for Evaluation (Ref. 2)

6. Audio Intercommunication Controls

A final capability to be added to the experimenter's station will be the controls for the audio/communication system. This system will provide intercommunication between the experimenter's station, the traffic controller, and the cockpit, and allow the interjection of sound effects and other pre-recorded audio information such as procedural instructions. The communication system should be arranged to allow the experimenter either to monitor or to speak over the voice link. This system will provide separate recording and reproducing capability.

7. Malfunction Simulation Controls

The malfunction simulation controls will be provided via the programmable multifunction keyboard described above under Item 4.

8. Facility Power and Environmental Controls

The facility power and environmental controls will be located at the extreme upper left of the operator's console.

This concludes our more detailed review of the experimenter's console and data acquisition system for the advanced technology simulation. A prototype for the traffic controller's console is shown in Fig. 18 from Ref. 99. In the next and concluding section of this report we shall summarize our conclusions and recommendations.

Figure 18. Example of Traffic Controller Station (From Ref. 99)

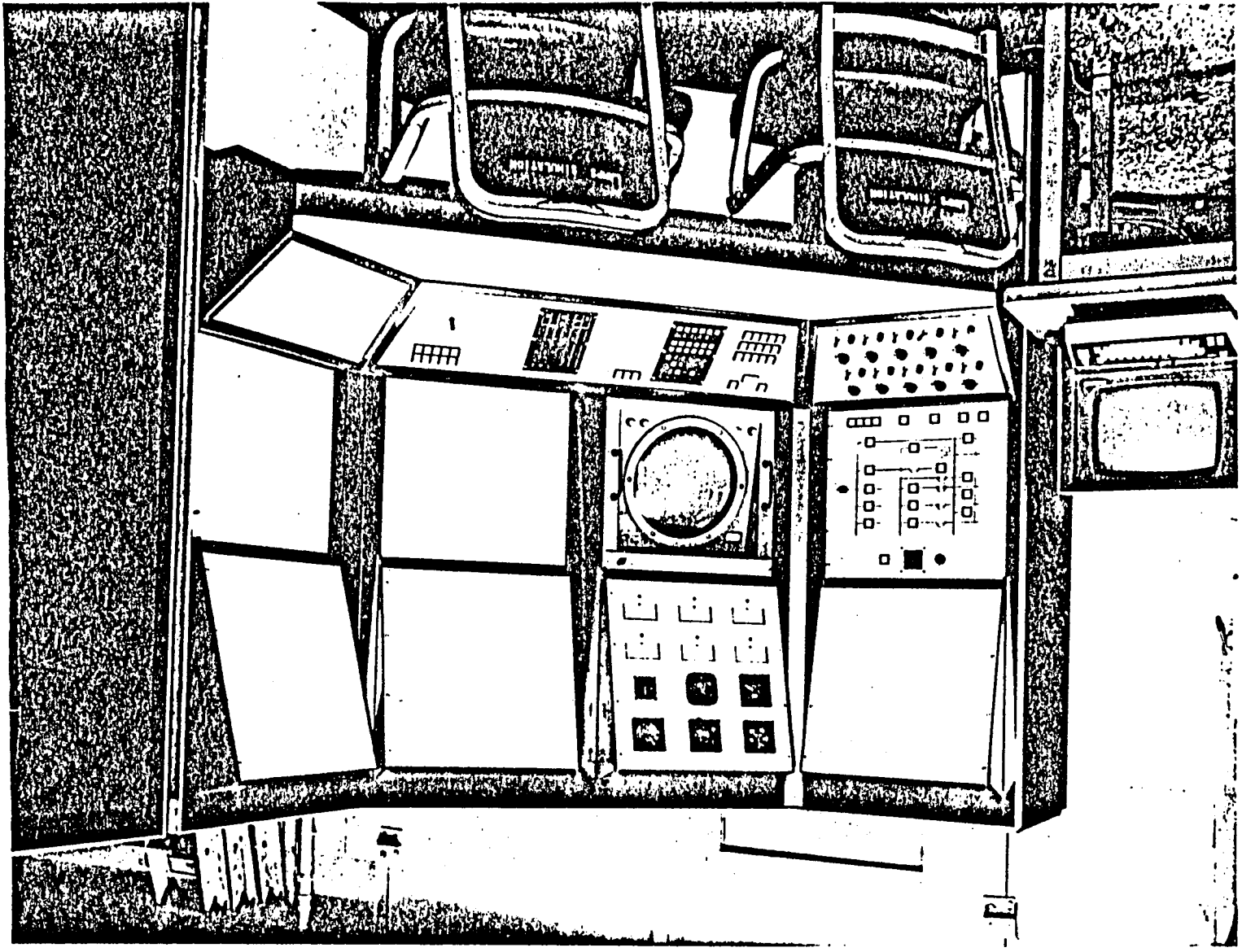

SECTION X

FACILITY INTEGRATION, CHECKOUT, AND STAFFING

A. FACILITY INTEGRATION

Given a selection of versatile compatible simulation equipment, we must now consider integrating the components into a useful and efficient facility. From the experimenter's point of view the experimenter's console and data printers/plotters provide a key facility interface. These devices must be configured and arranged to give the researcher a bird's eye view of facility status and subject performance, and provide a convenient means for changing experimental conditions. We have in Section IX recommended provision of capability in the experimenter's console which repeats the flight deck displays, crew performance indicators, and includes a variety of convenient displays, keyboards, and switches for controlling and monitoring simulator configurations.

An important feature of the facility is to provide on-line monitoring capabilities for the experimenter. However expenditures for this type of equipment are usually traded off against expenditures for storing the data in a form which can be readily retrieved for further processing. A common method is to digitize all data on magnetic tape which can then later be processed by a larger computer facility, but this approach by itself, while essential for archival storage, does not provide good on-line monitoring for the experimenter, unless, as recommended in Section IX, Fig. 14, the digital data is reconverted to analog form and routed at the same time to on-line displays for monitoring at the operator's console. For this purpose we have recommended the inclusion of 16 channels of analog-to-digital and digital-to-analog conversion interfaces for each flight deck in order to provide for crew comfort and performance monitoring from external analog equipment such as circular chart and strip chart recorders.

We have also recommended in Section IX that the facility expand this concept to include experimenter interaction with several computer

terminals which will provide computer control, display, and printout of simulator status software and summary results. Strip chart recorders and on-line data displays are recommended to provide the operator with appropriate on-line feedback of simulator and subject performance. The strip chart recorders also serve as a hard-copy record for permanent storage of dynamic data in real time which can be readily inspected after the acquisition of the data.

B. IMPLEMENTATION OF SIMULATOR MODELS

These tasks involve simulator software and hardware components and include their definition, implementation, and checkout — plus the documentation of their fidelity. All of these are required prior to the initial simulation facility test and evaluation, i.e., the formal taking of data.

1. Definition Phase

Definition of simulator software and hardware includes mathematical models of the environment (visual, electronic, and atmospheric), models of the airframe, all aircraft systems, control hardware, and the display design established in the preliminary analysis of scenarios. The major objective of the definition phase will be to produce a simulation data package.

2. Implementation Phase

The actual implementation phase consists of coding of software and installation of hardware at the MVSRF. This phase characteristically requires several months to execute from time of delivery of the data package to start of occupancy on the simulator facility. Engineers should coordinate closely with programmers in implementing model equations and being aware of the implications of simulator computer timing, computational algorithms, and program set-up. It has been found that failure to consider each of these items results in increased simulator check-out time

and increased operating problems during the simulation. Pitfalls to be avoided in the implementation include an excessive disparity between the simulator model document supplied by the engineers and the eventual simulation program as implemented by coding personnel.

3. Check-Out Phase

The check-out phase consists of the performance of check cases based on pre-computed results, the evaluation of check case results, and simulator trouble-shooting as required. The checking sequence to be applied will begin with basic airframe and propulsion system equations of motion and progress outward through the various navigation and guidance loop structure features until all aircraft systems have been checked. Quantitative functional checks will then be applied to cockpit control hardware, cockpit displays, and the simulator visual system hardware and software. Several forms of quantification will be used in the check-out phase and will include the static trim points, direct measurement of stability and control derivatives, direct measurement of describing functions, discrete responses to controls, comparison of time histories using overlays, and calibration of displays and visual scenes using direct overlays.

Although it is desirable to use the host computer for automatic simulation control, manual backup modes should be provided for in order to allow for debugging, component testing, special experimental control, and other non-routine task-scenario operations without having to reprogram the computer. The simulation must initially be checked out and demonstrated, and the check cases should be automated so they can be used routinely to verify proper simulator functioning. Two levels of checkout should be provided: one for a simple daily check before running subjects; and another more detailed set of tests to be used for thorough simulator validation and debugging of malfunctions. These checkout functions would be provided through a combination of computer routines and experimenter's console controls.

4. Fidelity Documentation

The final and perhaps most crucial step in the simulator implementation task will be documentation of simulator fidelity for the specific tasks to be considered. While documentation of fidelity is handled to some extent in the check-out phase, it will be necessary to employ a qualified pilot in order to quantify the most explicit aspects of simulator fidelity. The explicit fidelity items include the pilot's perceptual and control technique behavior which is induced by the simulator. The procedure will consist of the pilot flying several well-defined, routine tasks. In some cases the piloting behavior observed in the simulator can be compared directly with existing flight data or the simulator results can be stored for eventual comparison with flight data when available.

C. SIMULATION TEST PLAN DEVELOPMENT

What amounts to the final step in the facility integration and check-out and the first step in the simulation facility operational test will be development of an efficient simulation test plan.

1. Task Analysis

The development of the simulation test plan will require development of a scenario and a detailed task analysis to establish the normal and emergency procedures for each crew member, the probable task loop structures, level of perception (compensatory, pursuit, or precognitive), and the required or desired loop bandwidths. Examples of the task analysis appropriate to the full mission simulation scenario have been analyzed in Refs. 7 and 100. Other recent task analysis efforts for approach and landing have been included in Refs. 1 and 2. Procedures have been established for the quick and efficient gathering and analysis of simulation data in order to quantify any task of interest. Quantification of flying tasks can be handled for either direct reference to cockpit instruments or reference to an outside visual scene. We explain in Appendices A and B

how quantification of actual flight maneuvers can be used to establish and document basic simulator fidelity.

2. Unmanned Simulation of Tasks

The next step in the test plan development will be to exercise an unmanned simulation of the tasks previously analyzed. The conditions to be varied will include vehicle and aircraft systems, their levels of degradation, and environmental factors such as turbulence, wind shear profile, and daytime versus nighttime. The objective of this unmanned simulator exercise will be to establish meaningful levels of disturbances for the manned simulation. Primary metrics will be rms dispersions or absolute peak variations in the outer loop position states for each of the tasks to be considered. One matter of particular interest in the unmanned simulation will be determination of the criticality of visual system lags and delays. Past experience with the VFA-2 and VFA-7 Redifon visual systems at Ames Research Center have produced a keen awareness of the visual system fidelity pitfalls for tasks involving control of aircraft position.

3. Layout of Test Plan and Schedule

The final step in the test planning will be a detailed definition of test cells, their approximate time for running, and their most efficient sequential order. Based on past experience with simulator programs of this type, it has been found that:

- Barring the need for the ultimate full mission simulation involving several hours, facility test sessions involving all three crew members should be not shorter than 60 minutes and not longer than 90 minutes.
- Only a very restricted number of tasks should be considered during any one test session. It is often most effective to restrict the session to a single task or mission segment.
- The environmental conditions for each run should be sufficiently unpredictable to ensure that the crew is flying the aircraft rather than relying on learned simulator response.

D. STAFFING

The personnel required to operate and maintain the simulator are recommended based on our extensive operational experience with automotive and aeronautical research simulators. This experience indicates that five fields of knowledge and expertise are required as follows:

1. Experimental Designer. This individual generally works with the Principal Investigator to define the procedures, tasks, measures, and methods of analysis to be used in a given simulation. He also oversees the activities of the other members of the team.
2. Simulation Operator. This individual generally operates the simulation during experimental runs. He is intimately familiar with the whole simulation and routine on-line troubleshooting procedures.
3. Crew Performance Analyst. This individual assists the Principal Investigator at the experimenter's console in interpreting the on-line performance measures described in Ref. 2. More than one analyst, each with different skills, may be needed, for example, to interpret the procedure-centered, system-centered, and human-operator-centered measures described in Ref. 2
4. Crew Observer. This individual assists the Principal Investigator in the flight deck by observing crew operations directly and recording his observations and interpretations of events. The observer should possess the qualifications of a flight officer. He will, in addition, serve as the simulation check pilot.
5. Electrical Technician. This individual can repair and modify the electrical interfaces and components not covered under warranty.
6. Mechanical and Optical Technician. He is responsible for maintenance and special-purpose modification of the mechanical and optical equipment.
7. Minicomputer Programmer. This individual is necessary to maintain the software requirements of the simulation system.

We recommend that two individuals possessing each of these skills be full-time staff members of the facility and that additional programmers be

procured as required for initial software development and subsequent additions to the software. It will be most cost effective to contract for some special equipment maintenance such as that for the graphics generator hardware, digital computer(s), and primary control loading devices. Significant contract maintenance costs have been estimated for this special equipment, respectively in Tables 11 (Section III) and 17 (Section VI).

Finally, the overall simulation facility must be laid out with several considerations in mind:

- Proper environmental controls for the simulation hardware.
- Convenient arrangement for experimenter interactions with the equipment and subjects.
- Temporary work space for researchers.
- Shop area for equipment maintenance and modification.
- Suitable areas to brief and debrief subjects.

SECTION XI

CONCLUSIONS AND RECOMMENDATIONS

Putting together the foregoing facility organization, fidelity criteria, and critical operational scenarios, as well as the environmental, vehicle, crew station, visual, motion, control feel, and computational requirements, leads to a recommended overall Man-Vehicle Systems Research Facility plan which is summarized in Table 21. The bases of our recommendations for each item, and a more detailed breakdown of the specific functional requirements have already been given in each previous chapter.

A main point we wish to make here is that high quality, research grade equipment should be specified throughout the facility. However one must guard against facility "over-building" which has plagued several large simulation facilities recently. By taking advantage of gradual buildup of the more expensive items, as suggested herein, the costs may be held to nominal levels and the facility need not be over-built at the outset.

We believe that a simulation facility meeting the requirements outlined herein would accommodate most foreseeable man-vehicle systems research problems in commercial air transportation with high effectiveness and reasonable cost.

TABLE 20

RECOMMENDED MAN-VEHICLE SYSTEM RESEARCH SIMULATION FACILITY

Computer — Digital; distributed processors (four interrelated functions)

- Host (one each for Current Technology, Advanced Technology, and Air Traffic Control)
- Visual Field and HUD (one each for Current Technology and Advanced Technology)
- Display Graphics (Advanced Technology)
- Data Acquisition (one each for Current Technology and Advanced Technology)

Cockpits — • Two 4-place transport flight decks, each with optional growth provisions for motion system

- Advanced technology designed to accept panel-mounted calligraphic and raster graphic visual display units, modular feel simulation units, intercom, and sound generators
- Current technology based on contemporary training simulator flight deck

Visual Field Display — Cockpit-mounted displays plus collimating lens units

- Central field: Two 21-inch 800-line color monitor CRTs
(CTOL) Good quality, ± 45 deg field-of-view collimation lenses, close to pilot and copilot
- Parafoveal field (Optional growth provisions): two to-four 27-inch 550 line color CRTs,
(STOL) with collimation lenses
- Optional growth provisions for interposing framing, displays, HUD, or poor visibility between CRT and lens

Effective overall response time delay from the pilot's viewpoint, $\tau < 0.04$ sec (including host computation)

Moving Base — (Optional growth provisions for two 5-degree-of-freedom systems)

- Linear travel: ± 10 ft (5 ft min) lateral and vertical
- Angular travel (min): Pitch ± 30 deg, Roll ± 45 deg, Yaw ± 30 deg
- Frequency response at 50 percent travel:
 - Linear: Flat to 1 Hz, Effective time delay, $\tau < 0.2$ sec
 - Angular: Flat to 2 Hz, Effective time delay, $\tau < 0.1$ sec
- Other: Smooth and vibration-free

Control Feel Systems (Interchangeable modules)

- Basic Mechanical Module — two sets (three axes each) — two sizes
- Variable Force Producers — two modules (one axis each)
- Servo Actuator Simulators — two modules (one axis each)

Air Traffic Control

- Functional representation of terminal ATC with at least three controllers: two area and terminal
- Flexible and realistic intercommunication among at least three pseudopilots and both flight decks.
- Independent and simultaneous operation of both flight decks in the same airspace.

Experimenter's Console

- Current technology based on contemporary instructor's console for training simulator
- Advanced technology designed to accept visual display monitors and programmable multifunction keyboard, as well as the following functions.
 - (1) Performance monitor system
 - (2) Crew comfort monitor system
 - (3) System malfunction controls
 - (4) Data acquisition controls
 - (5) Operating controls
 - (6) Communication controls
 - (7) Environmental controls

Data Acquisition Media and Special Equipment (including data conversion)

- Soft copy (e.g., magnetic)
 - (1) Audio
 - (2) Video
 - (3) Coded digital signal data
- Hard copy (e.g., oscillographic data, digital data)
- Eye-Point-of-Regard
- Psychophysiological
- Any other special measures not included in simulation computers
 - (1) System bandwidth
 - (2) Describing function, remnant
 - (3) Excess control capacity
 - (4) Excess cognitive capacity
- Signal format and conversion equipment (A/D, D/A, D/D)

REFERENCES

1. McRuer, Duane T., Warren F. Clement, and R. Wade Allen, A Theory of Human Error, Systems Technology, Inc., Technical Report No. 1156-1, May 1980.
2. Clement, Warren F., Robert K. Heffley, Wayne F. Jewell, and Duane T. McRuer, Technical Approaches for Measurement of Human Error, Systems Technology, Inc., Technical Report No. 1156-2, July 1980.
3. Anon., Construction of Man-Vehicle Systems Research Facility, FY1981, Preliminary Engineering Report, Ames Research Center, July 1979.
4. White, Maurice D., National Simulator Survey, 4 June 1978.
5. Anon., MVSRF Initial Phase Review, 11-12 June 1980
6. Clement, Warren F., Investigation of the Use of An Electronic Multi-function Display and an Electromechanical Horizontal Situation Indicator for Guidance and Control of Powered-Lift Short-Haul Aircraft, NASA CR-137922, August 1976.
7. Anon., Man-Vehicle Systems Research Facility Experiment Planning Workshop, Summary Report, Ames Research Center, Moffett Field, California, MVSRF 105, 4-6 December 1979.
8. Wilson, J. W., and R. E. Hillman, "The Advanced Flight Deck," Aeronautical Journal, March/April 1980.
9. Huff, Edward M., and David C. Nagel, "Psychological Aspects of Aeronautical Flight Simulation," American Psychologist, March 1975, pp. 426-439.
10. Anon., Fidelity of Simulation for Pilot Training, Report of AGARD AMP/FMP Working Group 10, Draft of 1 March 1980.
11. Sinacori, John B., Piloted Aircraft Simulation Concepts and Overview, NASA CR-152200, March 1978.
12. NASA Ad Hoc Advisory Subcommittee, Avionics, Controls and Human Factors, 1980.
13. McRuer, Duane, Irving Ashkenas, and Dunstan Graham, Aircraft Dynamics and Automatic Control, Princeton University Press, Princeton, New Jersey, 1973.
14. McRuer, D. T., and E. S. Krendel, Mathematical Models of Human Pilot Behavior, AGARD-AG-188, January 1974.

REFERENCES (Continued)

15. Krendel, E. S., and D. T. McRuer, "A Servomechanisms Approach to Skill Development," Journal of Franklin Institute, Vol. 269, No. 1, 1960, pp. 24-42.
16. Sheridan, T. B., "The Human Operator in Control Instrumentation," in R. H. Macmillan, et al., (Eds.), Progress in Control Engineering, Academic Press, New York, 1962, pp. 141-187.
17. Clement, Warren F., Robert K. Heffley, and Wayne F. Jewell, Field-of-View Requirements for Approach and Landing of V/STOL Aircraft, NADC 77240-07, August 1978.
18. Gilinsky, Alberta S., "Perceived Size and Distance in Visual Space," Psychological Review, Vol. 58, 1951, pp. 460-482.
19. Gilinsky, A. S., "The Effect of Attitude Upon the Perception of Size," American Journal of Psychology, Vol. 68, 1955, pp. 73-192.
20. Hennessy, Robert T., Dennis J. Sullivan, and Herbert D. Cooles, Critical Research Issues and Visual System Requirements for a V/STOL Training Research Simulator, Canyon Research Group, Inc., Final Technical Report No. RTH-0180, 40-3053, 14 June 1979.
21. Gibson, J. J., The Perception of the Visual World, Boston, Houghton Mifflin, 1950, Chapters 6 and 7.
22. Graham, C. H., "Visual Perception," In A Handbook of Experimental Psychology, (Ed. S. S. Stevens), John Wiley, New York, 1951, pp. 868-920.
23. Gordon, D. A., "Static and Dynamic Visual Fields in Human Space Perception," J. of Opt. Soc. Amer., Vol. 55, No. 10, October 1965, pp. 1296-1303.
24. Gordon, D. A., "Perceptual Basis of Vehicular Guidance," Public Roads, Vol. 34, 1966, pp. 53-68.
25. Calvert, E. S., "The Theory of Visual Judgments in Motion and Its Application to the Design of Landing Aids for Aircraft," Trans. Illum. Eng. Soc., Vol. 22, No. 10, 1957.
26. Havron, M. Dean, Information Available from Natural Cues During Final Approach and Landing, Human Sciences Research, Inc., Report HSR-RR-62/3-MK-X, March 1962.

REFERENCES (Continued)

27. Naish, J. M., "Control Information in Visual Flight," Proceedings of the Seventh Annual Conference on Manual Control, NASA SP-281, June 1971 (also McDonnell Douglas Paper No. 5921).
28. Grunwald, A. J., and S. J. Merhav, "Vehicular Control by Visual Field Cues," IEEE Trans., Vol. SMC-6, No. 12, December 1976, pp. 835-845.
29. Noton, D., "A Theory of Visual Pattern Perception," IEEE Trans., Vol. SSC-6, No. 4, October 1970, pp. 349-357.
30. Sanders, A. F., "Some Aspects of the Selective Process in the Functional Visual Field," Ergonomics, Vol. 13, No. 1, 1970, pp. 101-117.
31. McColgin, F. H., "Movement Thresholds in Peripheral Vision," J. Opt. Soc. Amer., Vol. 50, No. 8, August 1960, pp. 774-779.
32. Linton, Paul M., and Warren F. Clement, "Predicting Field of View Requirements for VSTOL Aircraft Approach and Landing," AGARD-CP-268, January 1980, pp. 40-1 through 40-17.
33. Roberts, Edward O., External Visibility Criteria for VTOL Aircraft, AFFDL-TR-67-27, March 1967.
34. Clement, W. F., Some Pilot-Oriented Considerations of the External Field of View in Low-Visibility V/STOL Approaches, Systems Technology, Inc., Working Paper No. 510-29, April 1968.
35. Haines, R. F., "A Review of Peripheral Vision Capabilities for Display Layout Designers," Proc. Soc. Inform. Display, Vol. 16, No. 4, 1975, pp. 238-249.
36. Alex, F. R., Geometric Foundation of Motion Perspective, Systems Technology, Inc., Working Paper No. 170-3, January 1967.
37. Ebeling, William C., "A New Approach to Visual Simulation," J. of Aircraft, Vol. 6, No. 1, January-February 1960, pp. 59-64.
38. Bynum, J. A., W. G. Matheny, J. E. Flexman, and R. K. Wilson, Test of a Model of Visual Spatial Discrimination and Its Application to Helicopter Hovering Control, Life Sciences, Inc., LSI-TR-73-1, November 1973.
39. Thielges, J. R., and W. G. Matheny, A Review of the Analysis of Visual Discriminations in Helicopter Control, HumRRO Professional Paper No. 4-66, Presented to the Southwestern Psychological Association, Arlington, Texas, 21-23 April 1966.

REFERENCES (Continued)

40. Bynum, James A., Brian D. Shipley, and William C. White, "Helicopter Night Low-Level Navigation: Study 1 - Checkpoint Identification," AHS Preprint 1024 presented at the 32nd Annual National V/STOL Forum of the American Helicopter Society, Washington, D. C., May 1976.
41. Orlansky, Jesse, and Joseph String, Cost-Effectiveness of Flight Simulators for Military Training, Volume I: Use and Effectiveness of Flight Simulators, Institute for Defense Analyses, Paper P-1275, August 1977.
42. Smith, H. J., "Human Describing Functions Measured in Flight and on Simulators," Second Annual NASA/University Conference on Manual Control, NASA SP-128, 1966, pp. 279-290.
43. McRuer, Duane, and Richard H. Klein, Comparison of Human Driver Dynamics in an Automobile on the Road with Those in Simulators Having Complex and Simple Visual Displays, Systems Technology, Inc., Paper No. 173A, presented at the 55th Annual Meeting of the TRB, Washington, D. C., January 19-23, 1976.
44. Palmer, Everett, and John Petitt, "A Measurement of Psychological Realism on a Visual Simulator," Journal of Aircraft, Vol. 14, No. 5, May 1977, pp. 421-422.
45. Stapleford, Robert L., Piloted Aircraft Simulation -- Advantages, Disadvantages, and Practical Problems, Systems Technology, Inc., Paper No. 215, Presented at the SAE Air Transportation Meeting, May 1-4, 1978.
46. Jewell, Wayne F., Robert K. Heffley, Warren F. Clement, and Lt. Col. Thomas C. West (USA, Retired), "Simulator Studies of Powered-Lift Aircraft Handling Qualities in the Presence of Naturally-Occurring and Computer-Generated Atmospheric Disturbances," J. of Aircraft, June 1979, pp. 388-392.
47. Heffley, Robert K., A Model for Manual Decelerating Approaches to Hover, Systems Technology, Inc., Paper No. 228, September 1978.
48. Grodsky, Milton A., "The Use of Full Scale Mission Simulation for the Assessment of Complex Operator Performance," Human Factors, 9 (4), 1967, pp. 341-348.
49. Alluisi, Earl A., "Methodology in the Use of Synthetic Tasks to Assess Complex Performance," Human Factors, 9 (4), 1967, pp. 375-377.

REFERENCES (Continued)

50. Adams, J. A., "Research and the Future of Engineering Psychology," American Psychologist, Vol. 27, No. 7, 1972, pp. 615-622.
51. Clement, W. F., D. T. McRuer, and R. H. Klein, "Systematic Manual Control Display Design," Guidance and Control Displays, AGARD CP-96, February 1972.
52. Stapleford, R. L., R. A. Peters, and Fred R. Alex, Experiments and a Model for Pilot Dynamics with Visual and Motion Inputs, NASA CR-1325, May 1969.
53. Ringland, R. F., R. L. Stapleford, and R. E. Magdaleno, Motion Effects on an IFR Hovering Task -- Analytical Predictions and Experimental Results, NASA CR-1933, November 1971.
54. Ringland, Robert F., and Robert L. Stapleford, Experimental Measurement of Motion Cue Effects on STOL Approach Tasks, NASA CR-114,458, April 1972.
55. Jex, Henry R., and Raymond E. Magdaleno, Summary From "Roll Tracking Motion Cue Experiment" on the AMRL Dynamic Environment Simulator, Systems Technology, Inc., Working Paper No. 1094-6, 24 December 1977.
56. Durand, T. S., and G. L. Teper, An Analysis of Terminal Flight Path Control in Carrier Landing, Systems Technology, Inc., Technical Report No. 137-1, August 1964.
57. Heffley, Robert K., John M. Lehman, Robert C. Rumold, Robert L. Stapleford, Barry C. Scott, and Charles S. Hynes, A Simulator Evaluation of Tentative STOL Airworthiness Criteria. Simulation Results and Analysis (Final Report), NASA TM X-73,093 (also FAA-RD-75-222), November 1975; and Heffley, Robert K., John M. Lehman, Robert L. Stapleford, Barry C. Scott, and Charles S. Hynes, A Simulator Evaluation of Tentative STOL Airworthiness Criteria. Background Information (Final Report), NASA TM X-73,094 (Also FAA-RD-74-222), November 1975.
58. Rumold, R. C., and R. L. Stapleford, A Simulator Evaluation of Means of Improving Landing Precision of Short Haul Aircraft, Systems Technology, Inc., Technical Report No. 1059-1, August 1976.
59. Hoh, Roger H., and Wayne F. Jewell, Investigation of the Vulnerability of Powered Lift STOLs to Wind Shear, Systems Technology, Inc., Technical Report No. 1063-1, October 1976.

REFERENCES (Continued)

60. Jewell, Wayne F., Bruce A. Conway, and Warren F. Clement, Simulator Results of STOL Handling Qualities in the Presence of Naturally-Occurring and Computer-Generated Atmospheric Disturbances, Systems Technology, Inc., Interim Technical Report No. 1099-1, December 1977.
61. Graybiel, Ashton, "Some of the Mechanisms Underlying Motion Sickness," Paper presented at the NASA Symposium on Vehicle Ride Quality, Langley Research Center, Hampton, Virginia, 6-7 July 1972.
62. Jex, H. R., D. T. McRuer, R. W. Allen, and J. R. Hogge, Requirements and Program Plan for Simulation Facility and Data Handling for GM Design Staff Safety and Human Performance Group, Systems Technology, Inc., Technical Report No. 2039-1, March 1974.
63. Chase, Wendell D., Evaluation of Several TV Display Systems for Visual Simulation of the Landing Approach, NASA TN D-6274, March 1971.
64. Chase, Wendell D., "Evaluation of Several TV Display System Configurations for Visual Simulation of the Landing Approach," IEEE Trans., Vol. MMS-11, No. 3, September 1970.
65. Chase, Wendell D., "Computer-Generated, Calligraphic, Full-Spectrum Color System for Visual Simulation Landing Approach Maneuvers," Proceedings of the Society of Photo-Optical Instrumentation Engineers, Volume 59, Simulators and Simulation Design, Applications, and Techniques, 1975.
66. Chase, Wendell D., "Effect of Color on Pilot Performance and Transfer Functions Using a Full-Spectrum, Calligraphic, Color Display System," Presented at the AIAA Vision, Simulation, and Motion Conference, Dayton, Ohio, 26-28 April 1976.
67. Staples, K. J., "Current Problems of Flight Simulators for Research," Aero. Journal, 82:805, January 1978, pp. 12-32.
68. Allen, R. Wade, Jeffrey R. Hogge, and Stephen H. Schwartz, "A Simulator for Research in Driver, Vehicle, and Environment Interaction," Systems Technology, Inc., Paper No. 184, Presented at the 56th Annual Meeting of the Transportation Research Board, Washington, D. C., January 1977.
69. Picture System 2 Specifications, Evans and Sutherland, 1980.
70. Graphic 7 Specifications, Sanders Associates, Inc., 1976.

REFERENCES (Continued)

71. GCT-3000 Graphic Display System, Genisco Computers, April 1976.
72. 3400 Interactive Graphics Display System, Vector General, Inc., 1 July 1976.
73. 9000 Series Graphic Display System Description Manual, Ramtek Corporation, 1976.
74. Palmer, E., and J. Petitt, "Visual Space Perception on a Computer Graphics Night Visual Attachment," in Proc. of AIAA Visual and Motion Simulation Conference, 1976, pp. 88-95.
75. Palmer, E., and J. Petitt, "Difference Thresholds for Judgments of Sink Rate During the Flare," in Proc. of AIAA Visual and Motion Simulation Conference, 1976, pp. 96-100.
76. Stapleford, Robert L., Monthly Progress Report No. 1154-1 for Contract DOT-FH-11-9658, 9 November 1979.
77. "Pictures from Numbers," Flight International, Vol. 111, No. 3545, 19 February 1977.
78. Hodgkinson, J., W. J. LaManna, and J. L. Heyde, "Handling Qualities of Aircraft with Stability and Control Augmentation Systems — A Fundamental Approach," Aeron. J., Vol. 80, No. 782, February 1976, pp. 75-81.
79. Jex, Henry R., Wayne F. Jewell, Raymond E. Magdelano, and Andrew M. Junker, "Effects of Various Lateral-Beam-Motion Washouts on Pilot Tracking and Opinion in the 'LAMAR' Simulator," Proceedings of the Fifteenth Annual Conference on Manual Control, AFFDL-TR-79-3134, November 1979, pp. 244-266.
80. Jewell, Wayne F., Robert L. Stapleford, and Robert K. Heffley, Computed Responses of Several Aircraft to Atmospheric Turbulence and Discrete Wind Shears, NASA CR-152,181, February 1977.
81. Jex, H. R., R. E. Magdaleno, and A. M. Junker, "Roll Tracking Effects of G-Vector Tilt and Various Types of Motion Washout," Fourteenth Annual Conference on Manual Control, NASA CP-2060, November 1978.
82. Perry, D. H., W. G. A. Port, and J. C. Morrall, A Flight Study of the Sidestep Manoeuvre During Landing, Aeronautical Research Council, R and M 3347, July 1961.

REFERENCES (Continued)

83. Palmer, Everett, Tamara Mitchell, and John Pettit, Angular Size Estimation: A Measure of Simulator Visual Fidelity, (unpublished paper) No date, circa January 1979.
84. Sinacori, J. B., V/STOL Ground-Based Simulation Techniques, USAAVLABS TR-67-55, November 1967.
85. Heffley, Robert K., Robert L. Stapleford, and Robert C. Rumold, Airworthiness Criteria Development for Powered-Lift Aircraft. A Program Summary, NASA CR-2791 (Also FAA-RD-76-195), February 1977.
86. Heffley, Robert K., Wayne F. Jewell, John M. Lehman, and Richard A. Van Winkle, A Compilation and Analysis of Helicopter Handling Qualities Data. Volume One: Data Compilation, NASA CR-3144, March 1979; and Heffley, Robert K., A Compilation and Analysis of Helicopter Handling Qualities Data. Volume Two: Data Analysis, NASA CR-3145, March 1979.
87. Lehman, John M., Robert K. Heffley, and Warren F. Clement, Simulation and Analysis of Wind Shear Hazard, FAA-RD-78-7, December 1977.
88. Sinacori, John B., Robert L. Stapleford, Wayne F. Jewell, and John M. Lehman, Researcher's Guide to the NASA Ames Flight Simulator for Advanced Aircraft (FSAA), NASA CR-2875, February 1977.
89. Heffley, Robert K., and Wayne F. Jewell, Model Specification for a Generic Helicopter Simulation, Systems Technology, Inc., Working Paper No. 1164-1, June 1980.
90. Schulman, Ted. M., and Robert K. Heffley, Mathematical Models for a Boeing 727, a Cessna 310, and a Pseudo Pilot-Aircraft Model, Systems Technology, Inc., Working Paper No. 1164-2, forthcoming.
91. Vorst, Carl J., "A New Visual Simulation Technique for Pilot Training," Presented at the 9th Annual Naval Training Equipment Center/Industry Conference, Orlando, Florida, 9-11 November 1976.
92. EIA Standard; Interface Between Data Terminal Equipment and Data Communication Equipment Employing Serial Binary Data Interchange, Engineering Department, Electronic Industries Association, EAI RS-232-C, August 1969.

REFERENCE (Concluded)

93. IEEE Standard Digital Interface for Programmable Instrumentation; An American National Standard, New York, Institute of Electrical and Electronic Engineers, IEEE Standard 488-1975.
94. Mark 33 Digital Information Transfer Systems (DITS), ARINC Specification 429-3, 1979.
95. Aircraft Internal Time Division Command/Response Multiplex Data Bus, MIL-STD-1553A, 30 April 1975.
96. Hatcher, Jack G., Task TR A-104R1 Preliminary Layout of Advanced Cockpit Simulator, Model NASA Research TCV, Boeing D6-48649TN, 10 May 1979.
97. Runyon, Stanley, "Computer Graphics," Electronic Design, Vol. 24, No. 12, 7 June 1976, pp. 104-109.
98. Niemann, R. A., and K. Ziedman, Data Analysis for Driver Performance Studies. Volume II: A Computer Program for Analysis of Eye Movement Patterns, AMEX Systems, Inc., Report 0105, November 1974.
99. LAMPS Simulator System Description Mk-III H-2/SR, NADC Memorandum 5013-35, 30 June 1975.
100. Ruffle Smith, H. P., A Simulator Study of the Interaction of Pilot Workload with Errors, Vigilance, and Decisions, NASA TM 78484, January 1979.

APPENDIX A

A UNIFIED MEASURE OF VISUAL FIELD FIDELITY

The manually controlled decelerating approach to a hovering condition in a helicopter has been described as a time-varying maneuver for which closed-form solutions of the linear differential equation describing the range-dependent kinematics are not evident (Ref. A-1). A slightly altered differential equation has been formulated, however, in Ref. A-2, which combines the crossover model of the pilot-vehicle combination (Ref. A-3) with the effects of visual perception (Refs. A-4, A-5, and A-6) and yields a simple manual deceleration guidance law which agrees well with in-flight measurements of the range-dependent kinematics (Fig. A-1), which accompany the pilot's control actions. Although the visual manual deceleration guidance law is time-varying, it permits closed-form solutions for speed, acceleration, and time as functions of range to the hovering point. One potential use of the deceleration guidance law, which concerns us here, is as a simulator validation tool by comparing simulator measurements with in-flight measurements of the parameters A and k in the deceleration guidance law (Fig. A-1) while the helicopter is under visual manual control. In addition the same ideas applied to the deceleration task in Fig. A-1 can also be extended to vertical and lateral flight path guidance.

The key to describing (and measuring) the fidelity of the visual perspective (Fig. A-1) is provided in Ref. A-5 where the psychological measurements of apparent range and apparent size of essential cues in the visual field are related to various metrics of visual perspective. There it is shown that perceived range, R_p , is related to true range, R , by:

$$R_p = \frac{R}{1 + R/A}$$

where the length A is a characteristic measure of perceived range known as the apparent distance of vanishing points from the principles of perspective.

Analytical model of deceleration guidance

$$\frac{dR}{dt} = -k R_p = -k \frac{R}{1+R/A}$$

- Flight test data for one typical deceleration maneuver starting at 80 kt airspeed and 1000 ft altitude

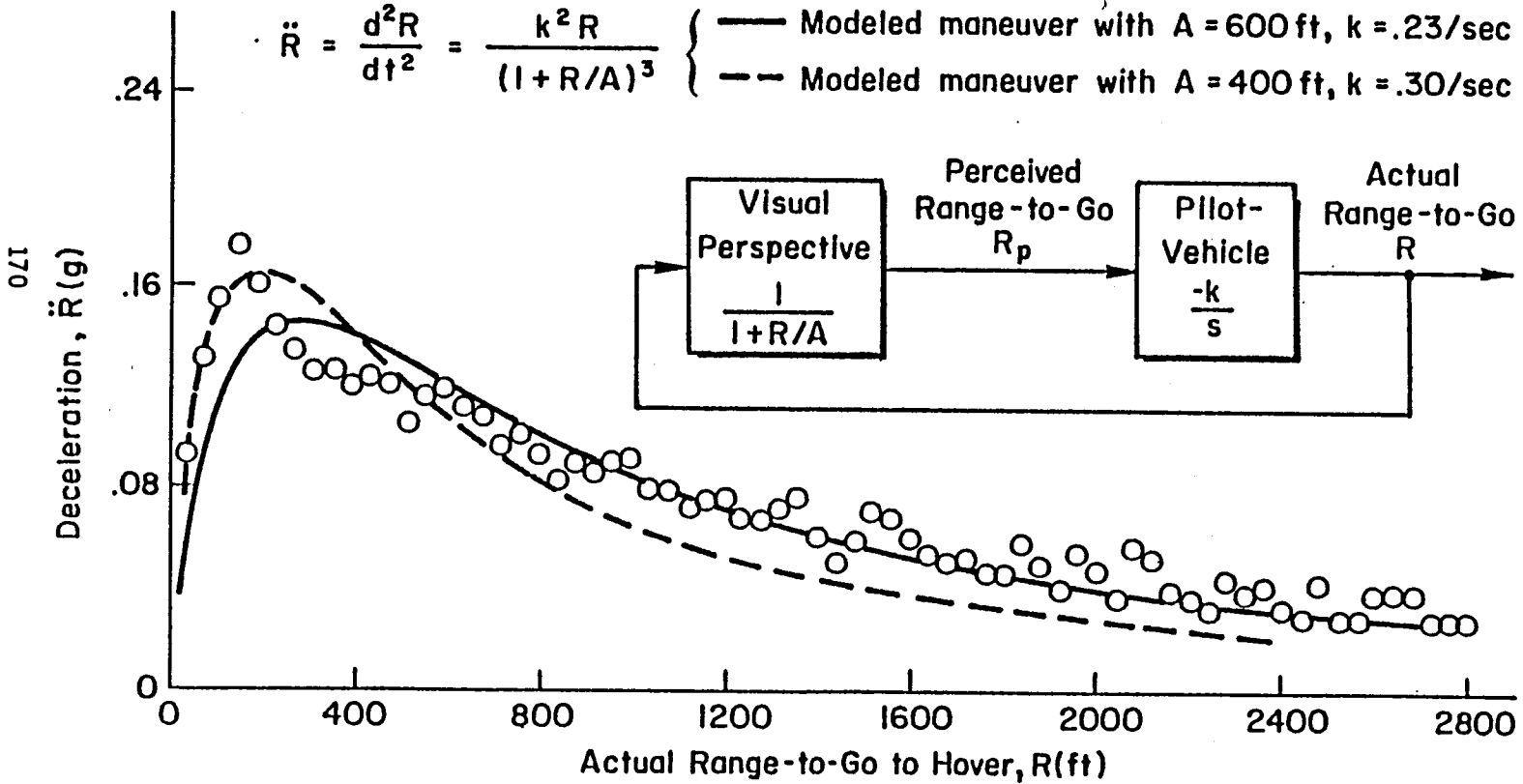

Figure A-1. Comparison of Deceleration Profiles Between Analytical Model and Flight Test Data

Likewise, perceived size, S_p , is related to objective true size, S_o , by:

$$\frac{S_p}{S_o} = \frac{R_p}{R} = \frac{1}{1 + R/A}$$

The value of k in the guidance law can be interpreted as the crossover frequency of the pilot-vehicle system, which represents the psychomotor bandwidth achieved by the pilot in the control task. Values of A and k identified in Ref. A-2 from the decelerating helicopter flight tests in Ref. A-1 are given in Fig. A-1 for eventual comparison with corresponding measurements from simulator tests.

Independent out-of-doors field measurements of A were made over twenty years ago by an entirely different technique using comparative apparent size judgments of two plain white isocetes triangles in daylight and reported in Ref. A-6. One of the isocetes triangles, called the "standard," was of constant physical size, but was viewed by the subjects at ranges varying from 100 to 4000 ft. The physical size of the other isocetes triangle was adjustable by the subjects, but the triangle remained at a constant range, $r_o = 100$ ft, and 36 deg to the right of the direct line of sight to the standard triangle in order to prevent simultaneous foveal viewing while the adjustment was being made to match the apparent size of the standard. The experimental site was a fairly level stretch of grassy terrain and the direct line of sight was parallel to an inactive airport runway 5000 ft long.

Since the adjustable triangle is always at range r_o , its perceived size will be $s_p = \frac{s}{1 + r_o/A}$, where s is the adjusted (objective) true size. The constant size triangle is viewed at varying ranges R , therefore its perceived size will be $S_p = \frac{S_o}{1 + R/A}$, where S_o is a constant. The subjects were instructed to adjust s so that $s_p = S_p$ while using binocular vision. The resulting objective size measurements are then related by

$$\frac{s}{S_o} = \frac{A + r_o}{A + R} = \left(1 + \frac{r_o}{A}\right) \left(1 - \frac{R}{A}\right)$$

The length A is thus the subjectively perceived range at which the size ratio s/S_0 tends to vanish. The mean out-of-doors field value of A extrapolated from the measurements in Ref. A-6 was 300 ft.

More recently, similar out-of-doors field measurements in daylight have been repeated and compared with measurements derived from analogous tests while the same subjects viewed collimated and uncollimated closed-circuit TV monitors displaying the same out-of-doors tests. The results for A have been calculated and are listed below based on data from Ref. A-7.

Out-of-doors, daylight 530 ft < A < 680 ft

Collimated TV monitor, daylight 216 ft < A < 239 ft

Uncollimated TV monitor, daylight 66 ft < A < 115 ft

These results for A imply that the collimation tended in part to compensate for the distortion of the visual perspective associated with direct viewing of the TV monitor*. The range of "out-of-doors" values for A is approximately the same as the range of values for A estimated from the helicopter deceleration flight tests in Fig. A-1.

Other analogous measurements have been derived from tests wherein the subjects viewed computer-generated imagery (CGI) consisting of calligraphic night visual scenes of an airport runway beside which the standard

* See Ref. A-8 for results of flight tests of blind landing performance using closed-circuit TV displays with iconoscope lenses having different focal lengths. The average error in touchdown point varied in linear proportion to the focal length of the lens. Thus:

- 1) Angular magnification, as with a telescopic lens, caused more undershoots (angular magnification tends to increase A)
- 2) Duplication of the perspective caused no mean bias in touchdown error
- 3) Angular reduction, as with a wide-angle lens, caused more overshoots (angular reduction tends to decrease A)

and variable triangles were alternately presented for comparative judgment. These results are reported in Ref. A-4, also for collimated and uncollimated viewing. Again the results for A have been calculated and are listed below based on data from Ref. A-4.

Collimated CGI, night scene	$76 \text{ ft} < A < 170 \text{ ft}$
Uncollimated CGI, night scene	$24 \text{ ft} < A < 70 \text{ ft}$

Since the comparable out-of-doors night scene was not tested for comparison, one is left to speculate among hypotheses for the much lower ranges for values of A. Again, however, the beneficial contribution of collimation is apparent in increasing the range for A.

SUMMARY

The apparent distance, A, of vanishing points in the visual perspective can be estimated from a variety of experimental tests in flight and in simulators. The values of A so obtained offer a unique measure of the fidelity of visual perspective for application to the simulated visual field devices.

REFERENCES

- A-1 Moen, Gene C., Daniel J. DiCarlo, and Kenneth R. Yenni, A Parametric Analysis of Visual Approaches for Helicopters, NASA TN D-8275, December 1976.
- A-2 Heffley, Robert K., A Model for Manual Decelerating Approaches to Hover, Systems Technology, Inc., Paper No. 228, September 1978.
- A-3 McRuer, Duane T., and Ezra S. Krendel, Mathematical Models of Human Pilot Behavior, AGARD-AG-188, January 1974.
- A-4 Palmer, Everett, and John Pettit, "A Measure of Psychological Realism on a Visual Simulator," J. of Aircraft, Vol. 14, No. 5, May 1977, pp. 421-422.
- A-5 Gilinsky, Alberta S., "Perceived Size and Distance in Visual Space," Psychological Review, Vol. 58, 1951, pp. 460-482.
- A-6 Gilinsky, A. S., "The Effect of Attitude Upon the Perception of Size," American Journal of Psychology, Vol. 68, 1955, pp. 173-192.
- A-7 Palmer, Everett, Tamara Mitchell, and John Pettit, Angular Size Estimation: A Measure of Simulator Visual Fidelity, (unpublished paper) No date, circa January 1979.
- A-8 Kibort, Bernard R., and Fred J. Drinkwater III, A Flight Study of Manual Blind Landing Performance Using Closed Circuit Television Displays, NASA TN D-2252, May 1964.

APPENDIX B

EFFECTS OF VARIOUS LATERAL-BEAM-MOTION WASHOUTS ON PILOT TRACKING AND OPINION IN THE "LAMAR" SIMULATOR (REF. B-1)

A series of moving-base flight simulator experiments has been recently performed using roll and sway motions of the Large Amplitude Multimode Aerospace Research Simulator (LAMARS) of the Flight Dynamics Laboratory at Wright-Patterson Air Force Base, Ohio.

The pilot's task was to follow an evasive (randomly rolling) target while suppressing gust disturbances. A two-independent-input technique produced behavioral data (describing functions) and performance data (error and control scores), which revealed how pilots used the visual and motion cues. Subjective data was also gathered on the tracking task as well as on limited "sidestep" maneuvers.

The objectives of these experiments were:

1. To tie in the roll-only visual-and-motion simulation results of the four experienced pilots with previous results (Ref. B-1) for four well-trained nonpilot subjects.
2. To investigate effects of various lateral-beam-motion "washout" filters designed to keep the lateral sway within the ± 10 ft of LAMARS travel. (lateral beam sway is used, within limits, to imitate the realistically "coordinated" lateral motions of free-flight roll maneuvers.)

We shall now present some of the results which characterize the pilots' judgments of "realism."

Although the pilots were encouraged to use their own words to describe the effects of the motion cues, there was a certain amount of commonality in the terms used by all the pilots. These are summarized below:

1. "Delayed side forces": These were side forces that were seemingly uncorrelated with the roll motion of the

aircraft. The specific force, $a_{y_{cab}}$, was not completely eliminated by translational acceleration, Y_{cab} , only attenuated and delayed by the sway axis washout filter. Some pilots said this felt like a student kicking on the rudder pedals.

2. "The leans": These were side forces that were perfectly correlated with the roll motion of the aircraft. The pilots described "the leans" as a pressure either on their knees or shoulders against the bulkhead of the cab when they knew their aircraft was rolled either left or right. Some pilots commented that when they were actively involved in the roll tracking task they did not notice "the leans" but the "delayed side forces" could be disconcerting.
3. "Change in the effective roll axis": The pilots felt that the effective roll axis was above them for roll-only motion. However for combined roll and sway motion the pilots could discern changes in the effective roll axis for various types of sway axis drive logic (i.e., various combinations of K_y and ω_y). This made the pilots feel as if they were on the end of a variable-length pendulum as K_y and ω_y were changed.
4. "Change in stick sensitivity": Although not a consistent comment, some pilots could discern changes in the effective stick gain for various types of sway-axis drive logic. This affected their impression of the task difficulty (e.g., "easier to fly now," or "more difficult to track now").

The pilots' subjective impressions of the motion cues, as described above, were used to define boundaries of acceptable combinations of the

parameters of the sway-axis washout filter. The resulting "boundaries" are summarized in the plot of K_y versus ω_y shown in Fig. B-1 (from Ref. B-1). The boundaries shown in Fig. B-1 intentionally appear nebulous for three reasons:

1. Pilot comments were not always repeatable, and many times the pilots admitted that the changes in the motion cues due to changing K_y and ω_y were very subtle. Therefore only relative judgments could be rendered, and the pilots' subjective impressions of the motion cues were a function of the starting points of the K_y , ω_y combination. The pilots were not told which combination of K_y and ω_y was being used, but they were told when a change in the value of either K_y or ω_y was made. This experimental technique was adopted because it was very difficult for the pilots to rate the motion cues on an absolute scale.
2. Pilot comments changed with the magnitude of the target's randomly rolling motion. The pilots were much more sensitive to changes in K_y and/or ω_y for the larger rolling amplitude than for the reduced amplitude. The difference in the pilot commentary is probably due to an indifference threshold on specific force (Ref. B-2 reports the a_y indifference threshold to be approximately 0.1 g).
3. Pilot comments changed with the task. This too was probably related to the pilots' indifference thresholds to specific force. For example, Fig. B-2a summarizes some pilot comments on a plot of peak a_y versus ω_y for $K_y = 0.9$. For bank and stop (sidestep) maneuvers the side forces become "disconcerting" when ω_y is greater than 0.4 rad/ sec (note that this is where the a_y peaks become greater than 0.1 g), but for the tracking task

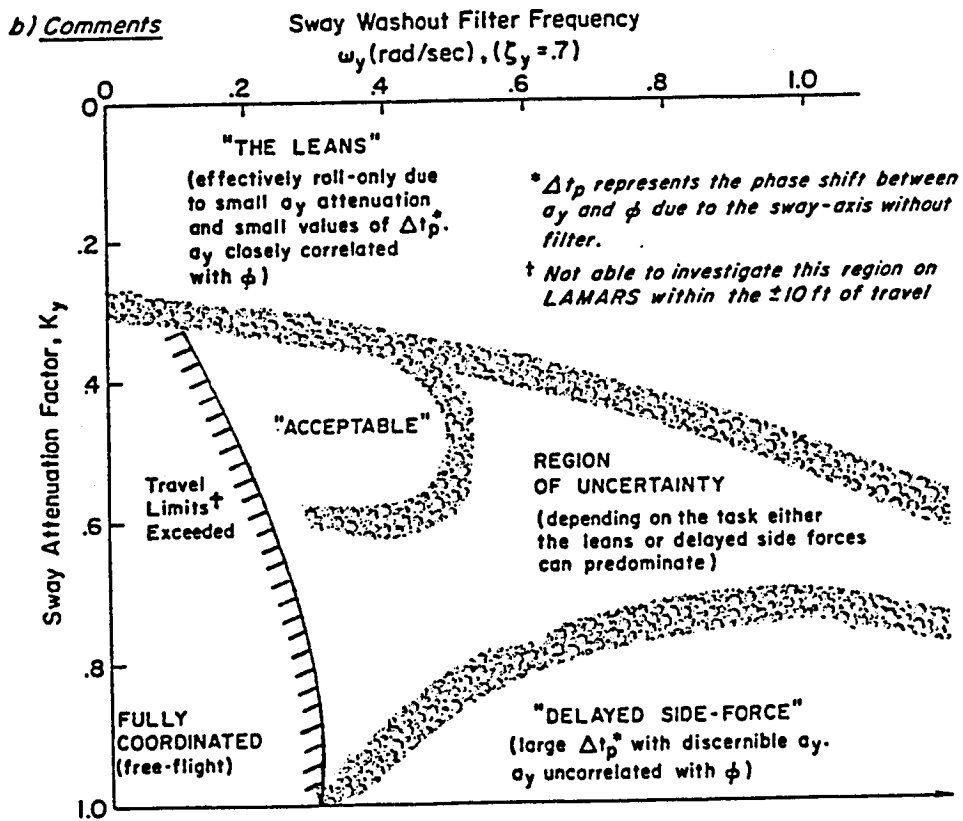
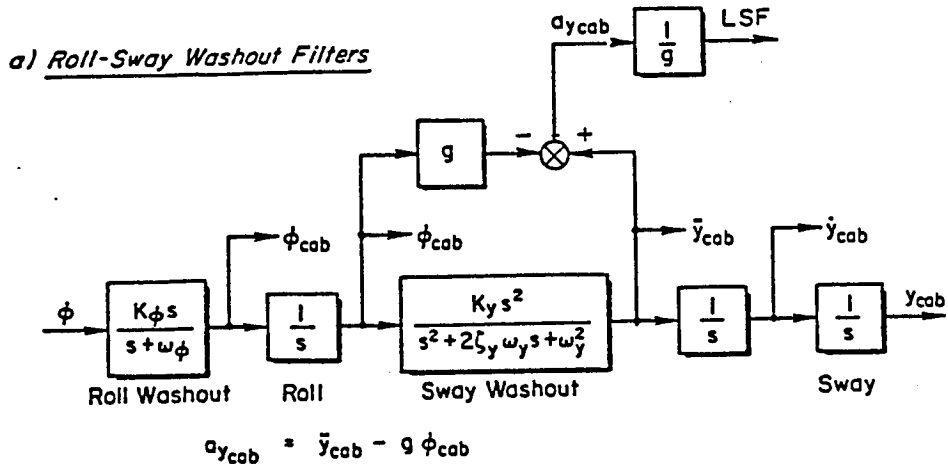
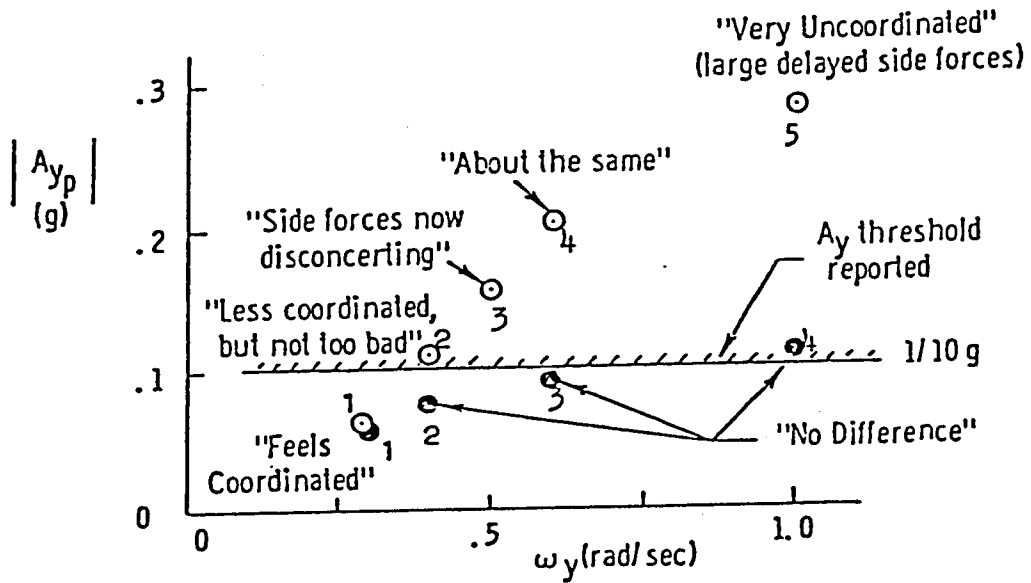

Figure B-1. Boundaries of Sway-Axis Washout Filter Parameters (From Ref. B-1) Which Delineate the Pilots' Impressions of Realism from Combined Roll and Sway Motion Cues

- Bank and stop maneuvers.
- Roll tracking with "reduced" input.

a) PEAK SPECIFIC FORCE VS. ω_y AT $K_y = .9$



b) PEAK SPECIFIC FORCE VS. K_y FOR $\omega_y = .3$ rad/sec

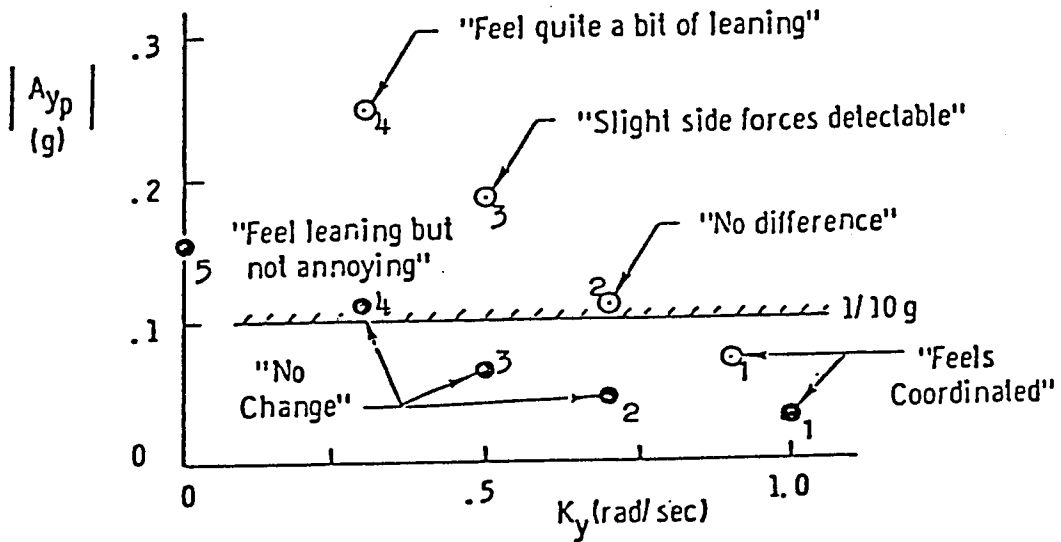

Figure B-2. Summary of Pilot Commentary for Bank and Stop Maneuvers and Roll Tracking

with the reduced input the pilot said "no difference" between $\omega_y = 0.3$ and 1.0 rad/sec (note that the a_y peaks just reach 0.1 g for $\omega_y = 1.0$ rad/sec). A similar phenomenon occurred when ω_y was fixed and K_y varied, as shown in Fig. B-2b. Also note from Figs. B-2a and B-2b that for small values of K_y with $\omega_y = 0.3$ rad/sec the pilot complained about the "leans," whereas for large values of ω_y with $K_y = 0.9$ the pilot complained about "lagged side forces."

Finally one other important comment was the pilots' universal displeasure with hitting the sway displacement limits. The adverse effects of hitting displacement limits have been observed in other simulators (e.g., Ref. B-3) and should be prevented by adopting nonlinear motion drive logic.

The nonlinear washout filter had the predicted attribute of preventing the sway displacement from hitting the LAMARS limits, because the amount of lateral travel used is extremely sensitive to ω_y (recall that ω_y is self-adaptive for the nonlinear filter). Otherwise back-to-back comparisons of the linear and nonlinear washout filters with the same value of K_y revealed no consistent differences in the pilots' subjective impression of the motion cues. The tracking scores obtained with the linear and nonlinear filters were virtually identical, and the pilot describing functions were also the same. However the amount of lateral travel used by the nonlinear filter was usually 30 percent less than that used by the linear filter during roll tracking. Except for occasionally greater peaks, this reduction in lateral travel was not otherwise accompanied by an increase in specific side force, a_y .

REFERENCES

- B-1. Jex, Henry R., Wayne F. Jewell, Raymond E. Magdaleno, and Andrew M. Junker, "Effects of Various Lateral-Beam-Motion Washouts on Pilot Tracking and Opinion in the 'LAMAR' Simulator," Proceedings of the Fifteenth Annual Conference on Manual Control, AFFDL-TR-79-3134, November 1979, pp. 244-266.
- B-2. Roark, Marvin, and Andrew Junker, "The Effects of Closed Loop Tracking on a Subjective Tilt Threshold in the Roll Axis," Fourteenth Annual Conference on Manual Control, NASA Conference Publication 2060, November 1978, pp. 443-450.
- B-3. Jewell, Wayne F., Warren F. Clement, Lt. Col. Thomas C. West, USA (Ret.), and Dr. S. R. M. Sinclair, Powered-Lift Aircraft Handling Qualities in the Presence of Naturally-Occurring and Computer-Generated Atmospheric Disturbances, FAA-RD-79-59, May 1979.

APPENDIX C

CONTROL-FEEL SYSTEM CHARACTERISTICS

We group the types of aircraft controls into two main categories:

1. Primary controls which include the "operating controls" (column, yoke, stick, pedals, throttles, thrust modulation devices, etc.) and the active trim controls (trim wheels, levers, beeper buttons, etc.)
2. Secondary controls which include various selector controls (speed brake operations, thrust reversers, flaps, slats, landing gears, etc.)

The feel properties which must be simulated for these classes of controls are shown in Table C-1. The remainder of this discussion is concerned with simulating the primary operating controls, where the fidelity of dynamic interaction with the pilot is of paramount importance.

Among the control-feel system characteristics which must be specified are the control displacement ranges, the force gradient characteristics for various flight regimes, and various nonlinear properties (e.g., preload, friction, and backlash). The control feel dynamics include the elastic and inertia characteristics, as well as force feedback effects from the servo actuator system itself (e.g., bottoming forces due to valve flow limitation, valve friction, and surface stops).

These feel characteristics have differing levels of importance for different classes of vehicles which are governed primarily by the role that the control-feel forces play in the more difficult control situations. The situations which define the control-feel system requirements are illustrated in Table C-2. The transport classes have been divided into: (a) conventional takeoff and landing, and (b) short takeoff and landing vehicles. For large conventional aircraft the crucial control-feel system requirements are the displacement ranges and dynamic force feedback effects. For STOL aircraft the control-feel system requirements center around the force gradient ranges, the numerous nonlinear features which make control difficult, and the dynamic characteristics of the feel system which can become closely coupled with the vehicle dynamic response.

TABLE C-1

COCKPIT CONTROLS AND FEEL CHARACTERISTICS

Class of Controls	Typical Transport Feel Characteristics Required	
	CTOL	STOL
<p><u>Primary</u></p> <ul style="list-style-type: none"> ● Operating Controls <ul style="list-style-type: none"> Column, Yoke, or Stick Pedals Throttle levers Powered-Lift or Thrust Modulation Conversion Manipulator ● Trim Control <ul style="list-style-type: none"> Handwheel or Lever "Coolie Hat" Beep Trim Functions (e.g., thrust deflector angle) 	<p>Preload, control system dynamics, feel gradient</p> <p>Preload, friction, gradient, control system dynamics</p> <p>Detents, adjustable friction</p>	<p>Detent, friction</p> <p>Adjustable friction, detents</p> <p>Adjustable friction</p> <p>Detent</p> <p>Spring centering gradient</p>
<p><u>Secondary</u></p> <ul style="list-style-type: none"> ● Selector Controls <ul style="list-style-type: none"> Speed Brakes Thrust Reverser Flaps and Slats Conversion Lever (step) Landing Gears 	<p>Detents, stops</p> <p>Detents</p> <p>Detents</p> <p>Detents</p>	<p>Detents, stops</p> <p>Detents</p> <p>Detents</p> <p>Detents, Adj. Friction</p> <p>Detents</p>

TR-1156-3

184

TABLE C-2

SITUATIONS DEFINING CONTROL REQUIREMENTS

Feel Characteristics	Vehicle Class	
	CTOL	STOL
<ul style="list-style-type: none"> ● Displacement ranges (e.g., nonlinear gearing, extremes) 	✓	
<ul style="list-style-type: none"> ● Force gradient dynamic ranges (e.g., dual or multi-gradients, maximum-minimum range) 		✓
<ul style="list-style-type: none"> ● Nonlinear features (static) (e.g., detents, stiction levels, backlash, etc.) 		✓
<ul style="list-style-type: none"> ● Dynamic effects <ul style="list-style-type: none"> ● Control system elastic and inertia characteristics, hysteresis and friction ● Actuator effects (e.g., valve flow forces, friction, rate limit) 	✓	✓

1. FUNCTIONS TO BE SIMULATED

Proper simulation of the detailed forces felt by a pilot can be extremely complex. Three types of forces are present: (a) basic column-yoke forces from the mechanical-inertial properties of the column, yoke, and cable or push-rod system, (b) bobweight forces from intentional or inadvertent mass unbalance in the system, and (c) servo actuator force feedbacks when a fully powered hydraulic control system is employed. These are shown in Fig. C-1. Even in the simplest simulation, at a fixed flight condition, and for conditions where the servo-actuator forces are negligible, one must simulate the proper control system friction breakout and apparent inertia. Pure viscous friction is seldom present in a basic mechanical column-yoke design (although it is often used to represent Coulomb friction) and viscous column dampers are seldom added to the system because their presence has usually been found to be adverse (one exception is when bobweights are used to increase feel forces). Feel changes due to dynamic pressure and due to the bobweight effects are next in likelihood of occurrence. Hydraulic servo actuator forces are usually of greatest concern when large control motions and rates are required, but the valve centering forces can be of importance even for the other flight conditions. More detailed references on the nature of these characteristics and their importance may be found in Refs. C-1 through C-4.

From the standpoint of the simulation system rather than the aircraft control system, the feel forces can be regrouped into three categories: (a) linearized forces including inertia, spring rate, and any viscous friction; (b) flight-dependent forces such as dynamic pressure feel and bobweight forces; and (c) nonlinear forces such as friction, preload, valve forces, etc., The basic linear and flight-dependent forces have only a modest bandwidth (on the order of a short-period frequency) while the nonlinearities require an extremely wide bandwidth for proper simulation (on the order of 100 Hz bandwidth or greater). To simulate all these characteristics with reasonably acceptable fidelity in a single force producer package coupled with an analog computer mechanization of the nonlinearities is an extremely difficult, expensive, and time-consuming

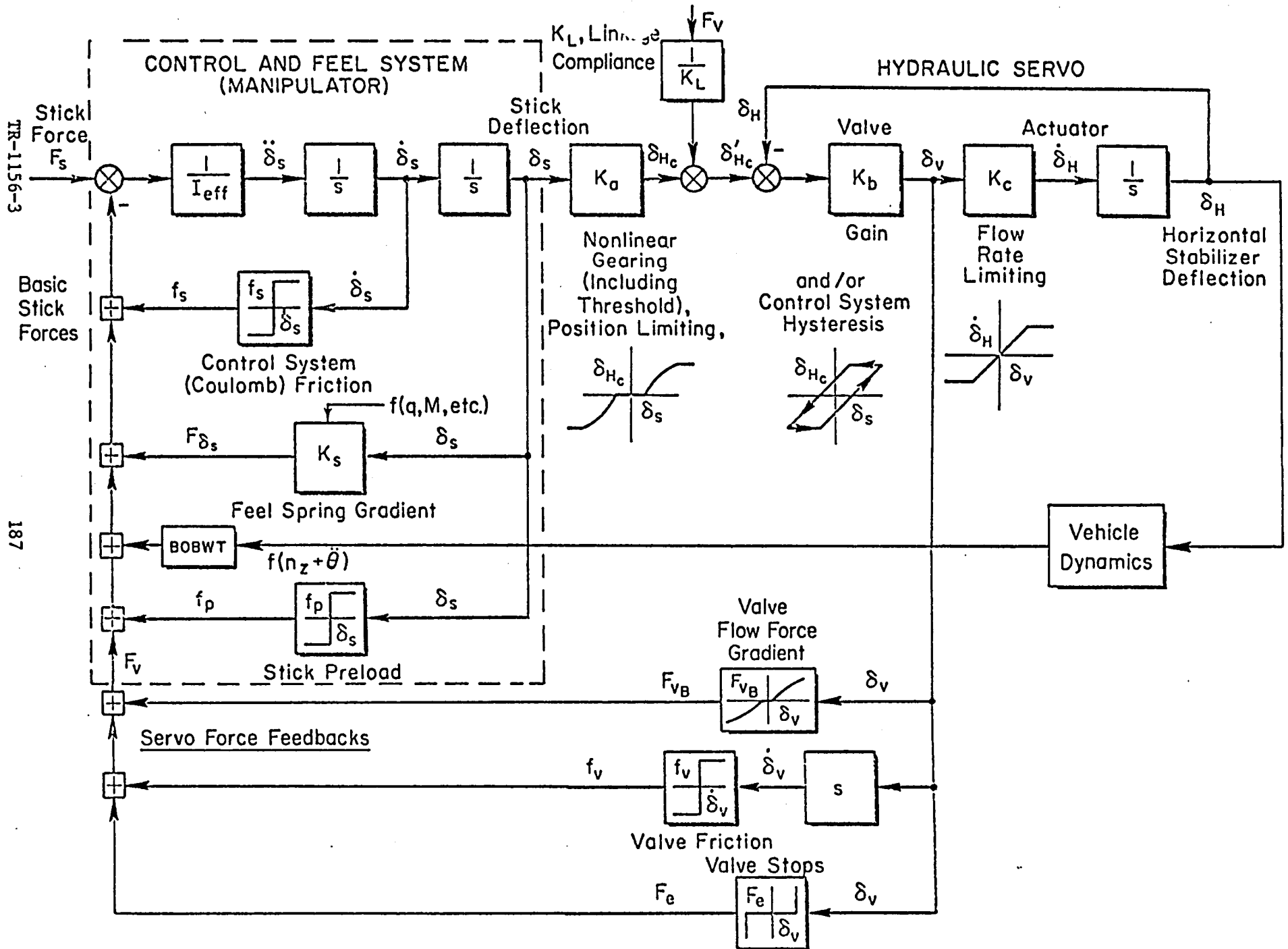

Figure C-1. Elements of Control Feel System Characteristics

proposition. For example, the best such systems known to us (built by McFadden Electronics Company) cost on the order of \$100,000. They include three axes of control and simulate some nonlinearities, require a hydraulic power supply, but do not include complete analog computer requirements or mechanical interconnection between pilot's and copilot's controls. Because even the simplest simulation setup will require simulation of friction and preload, multiple units of this type would be required.

The McFadden equipment uses lightweight low friction rotary actuators with hydrostatic bearings connected to the appropriate aircraft controls. The electro-hydraulic actuators are commanded by electrical analog force commands from a servo function-generating console incorporating fail-safe circuits to stop unsafe control motion. The actuators provide a smooth response at low spring gradients, and artificial feel characteristics can be easily modified, if it be desired to change the generated aircraft feel characteristics.

Simple dial adjustments of artificial force feel characteristics, such as spring, damper, preload, and friction, can provide an operator with realistic "feel" cues as if he were at the controls of any vehicle, including those in design. Systems are available using any combination of:

- One-axis, pitch, stick
- One-axis, yaw, rudder pedals
- Two-axis, pitch/roll stick, or control column/yoke

A separate deck of electronics is supplied to control each mechanical axis and is rack mounted in a compact electronic cabinet.

Whereas a fully powered hydraulic feel simulator of the type just described may be more desirable for the current technology flight deck, it would appear not to be as cost-effective for the advanced technology flight deck in which low inertia pedestal controllers are envisioned. Obviously a more practical solution is needed for the advanced technology flight deck. This is the electromechanical modular feel package to be described next.

2. MODULAR FEEL PACKAGES

After examining the simulation situation matrix of Table 5 (Section I), the foregoing material in this appendix, and our own experience with either consulting or building feel simulation units, a modular feel package concept has emerged. Several "basic mechanical feel modules" are provided to simulate the basic controller forces, a "variable force module" is used to simulate the Q-feel, multiple spring gradients, bob-weight, and trim forces (and certain low bandwidth nonlinearities) and a "power-servo-simulator module" is provided to simulate the complex servo force feedbacks. By arranging the design so that each of the three basic modules can be coupled to the same control axis and by providing more of the cheaper mechanical units and fewer of the expensive variable force units, a high degree of operating versatility can be achieved within practical cost limits. All the elements in these modules have been built and operated in the manner recommended here (e.g., Ref. C-2).

The basic mechanical module is coupled to a low inertia column or pedal assembly. Two sets of such assemblies should be designed, one to handle current technology aircraft, and another to handle advanced technology aircraft. Every effort should be made in the design of the columns and pedals to reduce the inertia to the minimum possible so as to be able to simulate a low inertia system in a passive manner.

The mechanical feel package is coupled by a jackshaft and pushrod to the control column. It comprises a mechanically variable inertia (e.g., through a variable gear or belt arrangement), an adjustable linear spring gradient, and cam-type preload and friction devices. The spring gradient, preload, and friction can be adjustable either by hand cranks or by a simple motor-driven jack screw. As in the case of the control column assembly, two pair of mechanical feel packages would be provided having different intrinsic ranges of variables to handle the two main classes of problems mentioned previously and to provide lower forces in the roll axis than in the pitch axis. The advantage in using such simple mechanical feel packages is that they are inexpensive, reliable, and are easily tailored to a given aircraft type. They provide excellent simulation of the

important nonlinearities of friction and preload without incurring simulator lags or artifacts. Low inertia, simple spring gradient manipulators may easily be simulated when one wishes to remove the feel system characteristics from the problem. Furthermore a noisy and unreliable hydraulic power supply system is not necessary for the majority of simple simulations, which will use this mechanical feel module alone. A standard design unit can be employed which is compact and straightforward with variations in the specific elements to accommodate the different general types of force requirement. It is possible to start with a simple three axis set of modules and to build others as time and problems require.

The second element in the feel simulation system is the variable force module. This unit is intended to provide modest bandwidth, analog computed force inputs such as Q-feel, multiple spring gradients, bobweight forces, trim forces, and some low bandpass feel nonlinearities. It does not have to handle extremely high bandwidth force feedbacks such as preload, friction, etc. The variable force module could be of the classic force-producer type (i.e., the position of the element is sensed and the required force is commanded whereupon the closed-loop force producer system reproduces the commanded force). Alternatively, it can be of the "force-sensed position-commanded" type in which the force on the controller is sensed by a stick transducer and the resulting displacement of the element in response to this stick command is computed on the analog computer. The commanded stick position is then achieved by a high bandwidth positioning servo system. For overall simulations, the latter system has been found to be more trouble-free and easy to achieve. However satisfactory units of the former type are now available commercially (e.g., McFadden Electronics Company sells force producer units for under \$10,000 each, depending on the bandwidth requirements). The specific choice between these two depends on factors beyond the scope of this investigation.

The advantage of the variable force module is that one basic design can be used on all simulation setups, since the forces it has to provide are small ones, added to the basic mechanical forces which are already provided by the mechanical feel module. If three such variable force modules are provided they can be used altogether on one three axis

simulation or separately on different simulations. The design of the mechanical unit should be such as to accept the variable force module input as one input on the jackshaft. The variable force module can also simulate some displacement sensitive effects such as multiple gradient springs, nonlinear inertia due to four-bar linkage effects, and cable compliance effects. In a pinch, it may be used to simulate the low bandwidth portions of certain servo actuator force feedbacks such as a "soft" valve bottoming and valve centering forces.

The correct simulation of a power servo actuator system is an extremely complex process in itself (e.g., see Ref. C-5) and is not recommended for the facility. On the other hand, we have found that an excellent simulation of the significant properties can be obtained quite inexpensively by using a specially modified small hydraulic servo actuator to serve as an analog for a larger unit. This is possible because only the small valve force properties of the servo actuator need be provided by the simulator, and these are always on the order of a few pounds or less. We recommend that a power-servo-simulator-module be provided which consists of a small hydraulic servo with an exaggerated valve travel. Valve friction would be provided externally, being adjustable by manual or servo means. The flow forces due to valve overlap or underlap can be provided mechanically with certain types of barrel servo valve. Flow rate effects can be provided by scaling the pickoff sensitivity relative to the mechanical travel. Compliance effects will also be simulated mechanically through a variable stiffness leaf spring. The design of such a unit is fairly straightforward; we have built and operated one quite successfully in past research (Ref. C-2).

The advantage of the power-servo-simulator unit is that it provides the simplest possible simulation of a set of very complex nonlinearities. Since large forces are not involved, very small and inexpensive units can be employed. Two or three such units would suffice for the whole facility since servo-valve nonlinearities are seldom limiting in all three axes during the same problem. They can be acquired gradually so as to minimize the costs and maximize their utilization.

For a given cockpit the recommended primary control feel simulation system thus consists of a basic mechanical module for each control axis, a variable feel module for at least the pitch axis and possibly others, if required, and a power servo simulator module when required. The variable feel and power servo modules would be designed to attach or detach easily from the basic mechanical module to permit easy interchange between the various simulation setups.

REFERENCES

- C-1 Crane, Harold L., Analog-Computer Investigation of Effects of Friction and Preload on the Dynamic Longitudinal Characteristics of a Pilot-Airplane Combination, NASA TN D-884, May 1961.
- C-2 Graham, Dunstan, Research on the Effect of Nonlinearities on Tracking Performance, AMRL TR-67-9, July 1967.
- C-3 Holladay, W. L., "Flight Control Influence on VTOL Handling Qualities," Proceedings of the 22nd Annual National Forum, American Helicopter Society, Washington, D. C., 1966, pp. 92-99.
- C-4 McRuer, D. T., and R. E. Magdaleno, Human Pilot Dynamics with Various Manipulators, AFFDL-TR-66-138, December 1966.
- C-5 Price, H. A., Mathematical Modeling by the Design Engineer, SAE Committee A-18, Paper presented to the Society of Automotive Engineers, New Orleans, Louisiana, 19-21 January 1966.

APPENDIX D

**PLASMA DISPLAY TERMINAL AND
PROGRAMMABLE MULTIFUNCTION KEYBOARD**

**Instrumentation Technology Corporation
Northridge, California**

TECHNICAL DESCRIPTION

Model: 9654
Revision:
Date: April 17, 1977
It: 1 of 4

INSTRUMENTATION
TECHNOLOGY
CORPORATION



18333 Eddy Street • Northridge, California 91325 • (213) 886-2034

ITC MODEL 9654

PLASMA DISPLAY TERMINAL

1.0 GENERAL

The ITC Plasma Display Terminal is a flexible, easy-to-use controller which can be used with any system that is RS 232 compatible. It "looks" and can be used as a teletype to a computer system, but can also be used for many different applications. Human-machine interface, a major aspect of the design, is accomplished through a programmable graphic display, with built-in operator touch control.

The heart of the system is a Digital Equipment Corporation LSI-11 microcomputer, which is software compatible with the PDP-11 family of minicomputers. The availability of extensive LSI-11 software makes the Model 9654 well suited to also be used as a stand-alone computing tool.

2.0 FUNCTIONAL DESCRIPTION

The display panel is an 80 x 256 dot matrix plasma display. Using microprocessor control, alphanumeric as well as graphics are displayed. As many as 288 characters (5 X 7 dot matrix) are displayed in the alphanumeric mode. In the graphics mode, special symbols, diagrams and pictures can be displayed.

The touch control panel is integrally packaged with the display unit. A 4-beam high by 16-beam wide grid can sense operator touch at any of 64 locations on the display panel. The touch panel/display provides an "intelligent" terminal under microprocessor control. It can be used as an alphanumeric terminal with keyboard and display, as an alphanumeric display, or as a symbolic display which senses operator inputs for controlling processes and gathering data.

TECHNICAL DESCRIPTION

Model: 9654
Revision:
Date: April 17, 1977
Sheet: 2 of 4

INSTRUMENTATION
TECHNOLOGY
CORPORATION



18333 Eddy Street • Northridge, California 91325 • (213) 886-2034

Dual RS-232 serial communication ports are controlled by an LSI-11 Processor. Data rates are independently programmable between 50 and 9600 baud. This provides compatibility with various computers, modems and other data communicative hardware.

Communication to the terminal via its RS-232 ports is similar to communication with a TTY except in the handling of lower case ASCII characters. The terminal does not display lower case characters; These characters are used as commands to the microprocessor in the terminal.

The functions of these characters are:

1. Terminal displays keyboard and responds as a TTY.
2. Terminal responds as a TTY but does not display keyboard.
3. Erases entire screen.
4. Erases a zone. Must be followed by four parameters defining the area to be erased in X-Y coordinates. The coordinates are the ends of a diagonal across the area. X values are from 0 to 255, while Y values are from 0 to 79. The coordinates are transferred in four binary bytes in the following order: X1, Y1, X2, Y2.
5. Displays a text string. The command must be followed by a byte string consisting of:
 - 1 byte specifying the line number 0 to 7.
 - 1 byte specifying the beginning character position in the line.
 - N Data bytes to be displayed.
 - 1 byte binary zero to terminate the string.
6. Displays one dot. Command must be followed by 2 bytes defining the X and Y coordinates of the dot.

TECHNICAL DESCRIPTION

INSTRUMENTATION
TECHNOLOGY
CORPORATION



Model: 9654

Revision:

Date: April 17, 1977

Sheet: 3 of 4

18333 Eddy Street • Northridge, California 91325 • (213) 886-2034

7. Build a box on the display. The command must be followed by 4 bytes defining the box in X-Y coordinates. The coordinates are the ends of a diagonal across the area. X values are from 0 to 255, while Y values are from 0 to 79. The coordinates are transferred in 4 binary bytes in the following order: X1, Y1, X2, Y2.
8. Set the maximum number of lines allowed to display. The command must be followed by 1 byte with a value in the range of 1 to 8.
9. Audio device generates 1 audible "Beep".
10. Senses panel switches. Returns when 1 switch is actuated. Data returned is switch number 0 to 63.
11. Same as above but waits until finger is removed from switch.

3.0 TECHNICAL SPECIFICATION

3.1 Touch Panel/Display:

Owens Illinois Digivue Model 80-33

Type:

Dot matrix plasma panel, alpha numeric information, graphics

Matrix Size:

256 dots wide X 80 dots high

Character Size:

5 X 7 dot matrix

Single Command Control:

One dot/one character/entire display

Cursor:

Display when used as an alpha numeric terminal

Cross Grids:

High Intensity IR LED source/detector

Vertical:

16 parallel beams

Horizontal:

4 parallel beams

Light Beam Interrupt:

Indicator:

Audio tone

TECHNICAL DESCRIPTION

INSTRUMENTATION
TECHNOLOGY
CORPORATION



Model: 9654

Revision:

Date: April 17, 1977.

Sheet: 4 of 4

18333 Eddy Street • Northridge, California 91325 • (213) 886-2034

3.2 Central Processing Unit:	DEC LSI-11
Word Size:	16 bits
Memory:	4K PROM/ROM
Memory Expansion:	2 slots, 16K RAM; or 8K ROM; or 4K each, ROM/RAM
Software:	I/O Drivers, self test diagnostics
3.3 I/O Interfaces	
Serial Asynchronous Data Interface	RS-232, two ports programmable to 9600 BAUD
3.4 Power Requirements:	115V rms, 60Hz, 1 ϕ \leq 300W
Size:	8-1/2" X 16" X 21" with enclosure covers removed.

1. Report No. NASA CR-166315		2. Government Accession No.		3. Recipient's Catalog No.	
4. Title and Subtitle Functional Requirements For the Man-Vehicle Systems Research Facility				5. Report Date October 1980	
				6. Performing Organization Code	
7. Author(s) W.F. Clement, R. W. Allen, R.K. Heffley, W.F. Jewell, H.R. Jex, D.T. McRuer, T.M. Schulman, and R.L. Stapleford				8. Performing Organization Report No. Tech. Rept. 1156-3	
				10. Work Unit No.	
9. Performing Organization Name and Address Systems Technology, Inc. 13766 South Hawthorne Blvd. Hawthorne, California 90250				11. Contract or Grant No. NAS2-10400	
				13. Type of Report and Period Covered Contractor Report	
12. Sponsoring Agency Name and Address National Aeronautics and Space Administration Washington, D.C. 20546				14. Sponsoring Agency Code	
15. Supplementary Notes Technical Monitor: David C. Nagel, Mail Stop 239-1, NASA Ames Research Center Moffett Field, CA 94035 (415) 965-6170 (FTS) 448-6170 See Also NASA CR-166313 and NASA CR-166314					
16. Abstract Relevant measurements based on a comprehensive analytical theory of the cause-effect relationships governing propagation of human error are indispensable to a reconstruction of the underlying and contributing causes. At present there is no national capability to implement the part-or full-mission flight simulation studies which are necessary to support the relevant measurements in the context of the national airspace system. NASA Ames Research Center has therefore proposed the Man-Vehicle Systems Research Facility to support the flight simulation studies which are needed for identifying and correcting the sources of human error associated with current and future air carrier operations. This report reviews the proposed organization of the Man-Vehicle Systems Research Facility and recommends functional requirements and related priorities for the facility based on a review of potentially critical operational scenarios. Requirements are included for the experimenter's simulation control and data acquisition functions, as well as for the visual field, motion, sound, computation, crew station, and intercommunications subsystems. The related issues of functional fidelity and level of simulation are addressed, and specific criteria for quantitative assessment of various aspects of fidelity are offered. The report concludes with recommendations for facility integration, checkout, and staffing.					
17. Key Words (Suggested by Author(s)) Human Error Aviation Safety Man-Vehicle Research Facility Simulation			18. Distribution Statement Unclassified - Unlimited Subject Category - 05		
19. Security Classif. (of this report) Unclassified		20. Security Classif. (of this page) Unclassified		21. No. of Pages 203	22. Price*

End of Document